

# Polar<sup>+</sup>Star



## USER MANUAL

---

Congratulations for choosing ***Polar Star***, a product stemming from Elcontrol 50-year experience in the control of energy consumption.

The high technology content, the careful attention to the choice of materials, the full compliance to the most recent industrial standards make this tool the 'Polar Star' for effectively and simply finding your way to energy analysis.

Further, Polar Star has been fully developed and tested in Italy. It is therefore manufactured with those high quality standards for all European products, in compliance with the environment, safety and ethics.

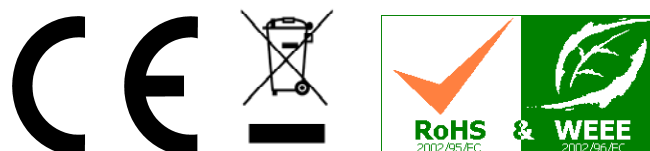

## TABLE OF CONTENTS

	Page	
1	Presentation	5
2	Safety	6
	2.1 Operator Safety	6
	2.2 RoHS & WEEE EC Declaration of Conformity	6
	2.3 Reference Standards	7
	2.4 Warranty Conditions	8
3	Installation	9
	3.1 Power Supply and Electrical Connections	9
	3.1.1 Power Supply	10
	3.1.2 Connection of Voltage and Amperometric Inputs	10
4	Start-up	13
	4.1 User Interface	13
	4.1.1 Set-up and Measurement Pages	13
	4.1.2 Keypad	14
	4.2 Programming and Set-up	15
	4.2.1 Connections Set-up	16
	4.2.1.1 Electrical Connection Set-up	16
	4.2.1.2 Voltage Ratio Set-up (VT)	16
	4.2.1.3 Current Ratio Set-up (CT)	16
	4.2.1.4 Current Ratio Set-up of I Neutral	16
	4.2.1.5 Cogeneration Set-up	16
	4.2.1.6 Neutral Current Set-up	16
	4.2.2 Minimum, Maximum and Average Set-up	17
	4.2.2.1 Integration Time Set-up	17
	4.2.2.2 Average Values and Maximum Demand Reset	17
	4.2.2.3 Minimum and Maximum Reset	17
	4.2.3 Counters Reset	17
	4.2.4 Language Set-up	17
	4.2.5 LCD Set-up	18
	4.2.5.1 Backlight Set-up	18
	4.2.5.2 Contrast and Brightness Set-up	18
	4.2.5.3 Menu Set-up	18
	4.2.6 Clock Set-up	18
	4.2.7 Bottom Bar Set-up	19
	4.2.8 Tariff Band Set-up	19
	4.2.8.1 Tariff Configuration and Reset	19
	4.2.9 Trend Set-up and Reset	20
	4.2.10 50160 Set-up and Reset	20
	4.2.11 Alarm Set-up and Reset	20
	4.2.11.1 Alarm Configuration	21
	4.2.12 Set-up Protection Password	21
5	Instrument Use and Consultation	22
	5.1 Connections Check	22
	5.2 Measurement Menu Scrolling	22
	5.3 Three-phase or Two-phase Connection Menu	27
	5.3.1 Voltage Menu	27
	5.3.2 Current Menu	28
	5.3.3 Power Menu	29
	5.3.4 Counters Menu	30
	5.3.5 THD Menu	31
	5.3.6 Harmonics Menu	31
	5.3.7 Waveform Menu	33
	5.3.8 Tariff Band Menu	34
	5.3.9 Trend Menu	35
	5.3.10 EN50160 Menu	36
	5.3.11 Alarm Log Menu	37

5.4	Single-phase Connection Menu	38
5.4.1	V I PF F Menu	38
5.4.2	P Q S PF Menu	39
5.4.3	Counters Menu	40
5.4.4	THD Menu	40
5.4.5	Harmonics Menu	40
5.4.6	Waveform Menu	40
5.4.7	Tariff Band Menu	41
5.4.8	Trend Menu	41
5.4.9	EN50160 Menu	41
5.4.10	Alarm Log Menu	41
6	Maintenance	42
6.1	Accuracy Checking	42
6.2	Repair	42
6.3	Trouble Tracing	42
7	Software Polarlink	43
8	Technical Specifications	44
9	Option Modules	46
9.1	RS485 Option Modules	46
9.1.1	RS485 Option Connections	46
9.1.2	RS485 Option Set-up	46
9.1.3	Communication Test	47
9.1.4	Date/Time Synchronization	47
9.1.5	MODBUS Measurement Registers	47
9.2	ALM Option	56
9.2.1	ALM Option Connections	56
9.2.2	ALM Option Set-up	56
9.2.3	Alarm 1 or 2 Set-up	56
9.2.4	Pulse 1 or 2 Output Set-up	57
9.3	Digital Inputs Option	57
9.3.1	Digital Inputs Option Connections	57
9.3.2	Digital Inputs Set-up	58

## 1 - PRESENTATION

**Polar Star** is a state-of-the-art device equipped with new functions for monitoring energy consumption and for advanced energy and quality analysis. This device is able to measure, display, process and transmit all the parameters of a plant.

With respect to standard energy analysers, its main features are as follows:

- ✓ new standard format enclosure (DIN 96x96 mm) which really conforms to IEC 61554, with a modern and sophisticated design:
  - reduced depth and only 4 cm overall dimensions inside the control board;
  - Front panel IP65 protection rating (total resistance to dust and water jets coming from all directions);
  - Plug & Play optional devices can be easily inserted at the back of the device (RS485 power supply digital input and output alarms, 12-24 Vdc and 48-60Vdc, **Wireless transmission**, etc.);
- ✓ for use with power supply and current and voltage inputs of flanged connectors (completely removable but with retaining screws) providing quick installation and total electrical safety thanks to the perfect tightening between male and female connectors;
- ✓ switching power supply, 90 ÷ 230V~ 50-60Hz and 90 ÷ 300V $\equiv$  (+ options 12÷24V $\equiv$  and 48÷60V $\equiv$ )
- ✓ backlit graphic LCD, high efficiency 128x128 pixels for a high quality display (multilingual menu, waveforms, histograms, customised pages, charts, **schemes**, images, etc.);
- ✓ 3 voltage measuring channels up to **600V Cat III**, with a  $\pm 0.25\% + 0.05\text{FS}$  accuracy
- ✓ 4 independent current inputs (3 + 1 which may be used for measuring, for example, the neutral current), with a  $\pm 0.25\% + 0.05\text{FS}$  accuracy
- ✓ 4 internal CTs for improved electrical insulation\*
- ✓ new calculation engine based on a new 16-bit microprocessor which provides measuring of all standard measures (V I P Q A F PF THD% etc.) with effective value (TRMS) and:
  - measuring of minimum, average maximum and instant values on 4 dials (absorbed and generated type)
  - password-protectable energy counters (kWh kVA kVAr) for both absorbed and produced energy;
  - Energy quality analysis through measuring of:
    - current and voltage harmonics (all 7 input channels) up to the 31<sup>st</sup> order;
    - power and micro-power blackouts\*
    - Dips (voltage losses)\*
    - Swells (overvoltages)\*
    - EN50160 test (reference standard for energy quality)\*
  - Event data logger (5 alarms, 5 dips, 5 swells, 5 interruption)\*
  - graphic display of trends (time progress) of 5 selectable measures\*
  - energy measurement in 4 time periods (tariffs)\* (tariffs can be freely set)
  - **For both three-phase and each single phase!!!**
  - 6 electrical systems which can be analysed: (i) single-phase type; (ii) two-phase type; (iii) three-phase with 3 leads (unbalanced type); (iv) three-phase with 4 leads (unbalanced type); (v) three-phase with 3 leads (balanced type); (vi) three-phase with 4 leads (balanced type);
  - mean voltage connection is possible
- ✓ Users can customise the screens according to their preferences;
- ✓ Multilingual menu (English, Italian, German, Spanish and French);
- ✓ Automatic test connection for checking the electrical connections;
- ✓ Automatic option recognition;
- ✓ Check of RS485 communication (if any);
- ✓ Dedicated PC software for detecting and remotely configuring the instrument\*

\* only for **TOP model**

## 2 - SAFETY

Polar Star has been designed and tested in compliance with the most recent industrial Directives and is supplied by the manufacturer in perfect technical safety conditions. In order to maintain these conditions and ensure safe operation, the user should follow the instructions and the markings in these user instructions.

**Read these pages carefully before installing and using this device!**

### 2.1 - Operator Safety

- The instrument described in this manual is intended to be used only by properly trained personnel.
- Maintenance and installation operations should be carried out only by qualified and authorised personnel in order to avoid any risk of electrocution, shock or burns.
- For proper and safe use of the device and for its installation and maintenance, the people in charge of these operations should observe standard safety procedures. Failure to do so will relieve the manufacturer of all responsibilities.
- Before using, servicing or repairing, disconnect the instrument and the housing board from any voltage source.
- Before performing the electrical connections or any interventions on the device, short-circuit the CT secondary winding and switch off the power supply.
- Before the start-up, check the following:
  - ! network voltage should fall within the range indicated in the specification;
  - ! the maximum voltage at the voltage inputs should be 700VAC phase/phase or 400VAC phase/neutral
- After checking that safe operation is no longer possible, the instrument should be taken out of service and ensured against accidental use. Safe operation is no longer possible in the following cases:
  - ! when the instrument exhibits clearly visible damages;
  - ! when the instrument is not working anymore;
  - ! after long storage under negative conditions;
  - ! after serious damages undergone during transport.

When you find this symbol on the product or anywhere else, you have to consult the instruction manual.



### 2.2 - RoHS & WEEE EC Declaration of Conformity

Manufacturer: **ELCONTROL ENERGY NET S.r.l.**  
Via Vizzano 44 - 40044 Sasso Marconi (BO) - Italy

Product: **POLAR STAR** Energy Analyser

Compliance with Directives: **93/68/EEC** (LV electrical equipment);  
**89/336/EEC** and **2004/108/EC** (EMC - Electromagnetic Compatibility)  
**2006/95/EC - 72/23/EEC** (LVD - Low Voltage Directive);  
**2002/95/EC** (RoHS - Restriction of Hazardous Substances);  
**2002/96/EC** and **2003/108/EC** (WEEE: Waste Electrical and Electronic Equipment)

Mark affixing date: 2009

Reference standards taken into account for EC compliance: IEC EN 61010-1  
IEC EN 61326  
IEC EN 61326/A1  
IEC EN 61326/A2  
IEC EN 61326/A3

Reference standard for mechanical dimensions: IEC 61554 (ex DIN 43700)

**2.3 - Reference Standards**

IEC standard	Title	Description	Internat. Connect.
EN 61010-1	Safety requirements for electrical equipment for measurement, control and laboratory use.	General safety requirements for electrical equipment for professional, industrial and educational use: test and measuring electrical equipment for setting and laboratory.	Identical to IEC 61010-1:2001-02 EN 61010-1:2001-03
EN 61326	Electrical equipment for measurement, control and laboratory use. EMC requirements.	The present standard indicates the minimum requirements for immunity and issue as regards the electromagnetic compatibility of electrical equipment with power supply lower than 1,000 V AC or 1,500 V DC for professional and educational use or for industrial processes including electronic processing devices and equipment: measuring and test summation; control summation, summation for laboratory use, summation for accessories which are not intended to be used with the above-mentioned equipment.	Identical to IEC 61326-1: 1997-03 EN 61326-1:1997-04 EN 61326-1 Ec:1998-01
IEC EN 61326/A1	Electrical equipment for measurement, control and laboratory use. EMC requirements.	The present Variation modifies the requirements for immunity tests indicated in the standard IEC EN 61326 for the following special applications: use in industrial environment; use in laboratory or test and measurement areas with electromagnetically-controlled environments; portable test and measurement equipment which are powered by batteries or by the circuit to be measured.	Identical to IEC 61326-1/A1: 1998-05 EN 1326/A1: 1998-06 EN 61326-1 (1998-09)
IEC EN 61326/A2	Electrical equipment for measurement, control and laboratory use. EMC requirements.	This Variation adds an annex to the basic Standard which introduces more detailed EMC requirements for certain pieces of equipment for use without particular protections. These requirements concern test configurations, working conditions and performance criteria. Below are some examples of equipment: oscilloscopes, logic analysers, spectrum analysers, digital multimeters, etc.	Identical to IEC 61326-1/A2: 2000-08 EN 61326/A2: 2001-05
IEC EN 61326/A3	Electrical equipment for measurement, control and laboratory use. EMC requirements	The present Variation to IEC EN 61326 (IEC 65-50) adds Annexes E and F to the basic Standard. These annexes concern test configurations, working conditions and performance criteria for portable test and measurement equipment that are used in low voltage distribution systems.	Identical to: IEC 61326:2002-02 (Annex E & F); IEC 61326/Ec1:2002-07 EN 61326/A3:2003-12

## 2.4 - Warranty Conditions

### **WARRANTIES AND DISCLAIMERS**

Elcontrol guarantees that each Polar Star is free from defects, complies to the technical specifications and is suitable for the purposes declared by Elcontrol for a period of *twelve (12) months as from the documented purchase date* or, in the absence of such date, the calibration date.

The warranty covers faulty hardware parts, but it does not include software, labour costs, consumables and transport charges.

The repairs under warranty will only be performed if Elcontrol acknowledges actual manufacturing defects or poor material quality.

This warranty becomes void if the defect is caused by: wrong electric power supply, overvoltages, wrong connection, tampering with the device, repair or modification without the manufacturer's prior permission, shocks or use other than that described in the user manual's conditions. No damages caused by the product remaining unused or by third parties shall be acknowledged.

Faulty products shall be returned to the importer/distributor of your country or to Elcontrol CARRIAGE FREE, subject to prior authorisation of Elcontrol.

A repair request under warranty shall be accompanied by a proof-of-purchase document indicating the purchase date. Elcontrol cannot be held responsible for products which have not been paid by the purchaser within the provided deadlines and if the faulty product comes back from a Country other than that where the product has been sold, unless otherwise agreed.

### **DEFECT REPORT**

Any report relating to product defects, whether these are apparent or latent, shall be forwarded to Elcontrol in written form.

Under no condition may the purchaser return the products without prior permission of Elcontrol or after a decision of the Judiciary Authority.

Products shall be returned within ten (10) days as from Elcontrol's or the Judiciary Authority's authorisation.

In case of report, irrespective of the object and the reason, the purchaser shall pay the entire amount indicated on the invoice. If the delivered products are modified, changed or used by the purchaser, no report shall be accepted or considered as effective.

Discrepancies which are considered customary in the market, as well as technical discrepancies which cannot be avoided, especially those concerning quality, colours, manufacturing, graphics and others, shall not be claimed.

Elcontrol reserves the right to introduce changes to its products without altering their quality or performance. These changes cannot be challenged.

When Elcontrol receives a report based on product conditions, defects or non compliance to the technical specifications, Elcontrol has the exclusive right to replace the products without any charge, to repair the products or to issue a debit note.

Any kind of damage is excluded.

In case of interventions under warranty period, all shipping charges of faulty products for repairing and/or replacing are at the purchaser's charge.

### **LIMITATION OF LIABILITY**

Except for the warranty, Elcontrol does not take any responsibility for direct or indirect damage to the purchaser, such as material damage, damage for loss of earnings, for losses or damage to documents, archives or purchaser's data, damage for third party claim, other damages stemming from applications obtained by the purchaser for themselves or third parties with the help or by means of products purchased from Elcontrol.

### **FINAL PROVISIONS**

The present warranty conditions supersede any other obligations and warranties which were agreed on by the parties orally or in written form before the purchase of Polar Star. Any other possible obligations or warranties shall be considered null and void.

### 3 - INSTALLATION

Polar Star is installed to a panel via DIN 92x92 windows, according to IEC 61554 (ex DIN 43700) and blocked with the clamping band supplied.

Fig. 1 shows the mechanical dimensions of the product and its corresponding drilling template.

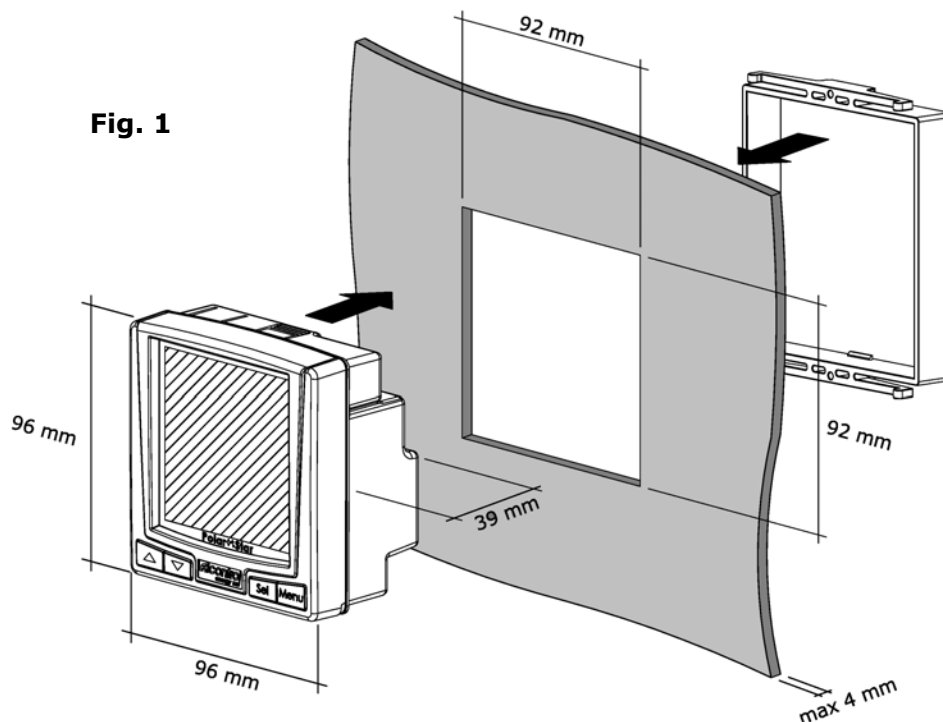

**Fig. 1**

Moreover, it is possible to obtain the IP65 protection rating also for the drilling template by using the O-ring which can be ordered separately.

Polar Star can be installed on plates and/or panels, the thickness of which should not exceed 4 mm (or 3 mm if the O-ring is inserted)

**NOTE:** for connecting and starting up the optional modules, please refer to the relevant option manual

#### 3.1 - Power Supply and Electrical Connections

**Fig. 2**

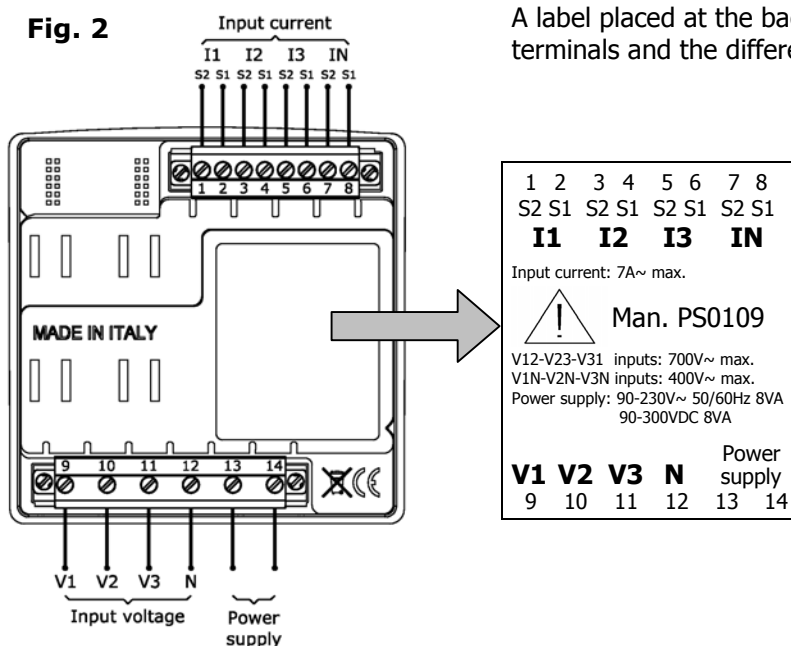

A label placed at the back of Polar Star helps you identify the terminals and the different connections.

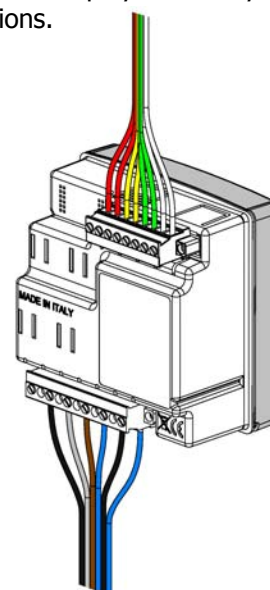

### 3.1.1 - Power Supply

Polar Star has 2 terminals for supply voltage which are marked *Power supply* (Fig. 2).

Polar Star can be powered from **90 to 230 V $\sim$** , with a +/-10% tolerance. Power supply frequency may be, without distinction, **50Hz or 60Hz**.

Alternatively, it may be powered through direct current from **90 to 300 V $\equiv$**  +/-10%

Polar Star is not equipped with internal fuse protection; one **200mA delayed fuse** should therefore be added on each power supply conductor.

By using the relevant option module, the device may be powered at **12+24V $\equiv$**  or **48+60V $\equiv$** .

For installation and use of this device, please refer to the relevant option manual.

### 3.1.2 - Connection of Voltage and Amperometric Inputs

Polar Star has 3 voltage inputs called V1, V2 and V3, with common neutral (N).

Similarly, the instrument has 4 independent current inputs: I1 I2 I3 IN (neutral current, also known as 4<sup>th</sup> channel for auxiliary measurements).

**YOU MUST SHORT-CIRCUIT THE CTs BEFORE CONNECTING THEM TO THE INSTRUMENT!**



For the connection of the above-mentioned inputs to the network voltage, please refer to:

- Fig. 3 - Unbalanced three-phase network with neutral (4 leads / 3+1 CT)
- Fig. 4 - Balanced three-phase network with neutral (4 leads / 1 CT)
- Fig. 5 - Unbalanced three-phase network without neutral (3 leads / 3 CTs)
- Fig. 6 - Unbalanced three-phase network without neutral (3 leads / 2 CTs)
- Fig. 7 - Balanced three-phase network without neutral (3 leads / 1 CT)
- Fig. 8 - Two-phase network (3 leads / 2 CTs)
- Fig. 9 - Single-phase network (2 leads / 1 CT)
- Fig. 10 - Example of connection via Voltage Transformer

**Fig. 3: 3PH+N**

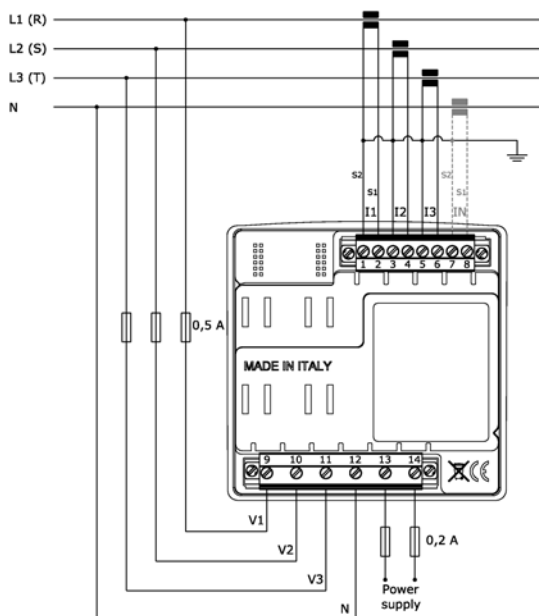

**Fig. 4: 3PH+N-BL**

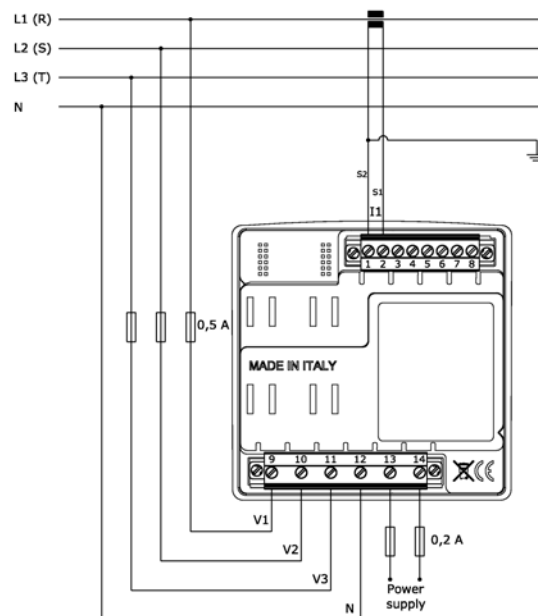

**Fig. 5: 3PH**

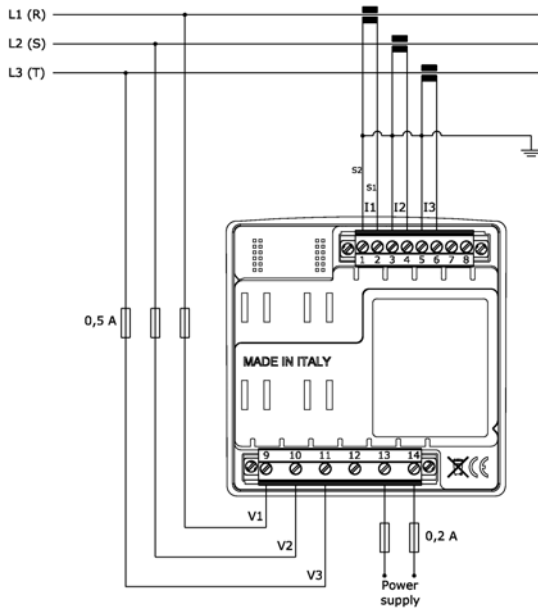

**Fig. 6: 3PH (2 CT)**

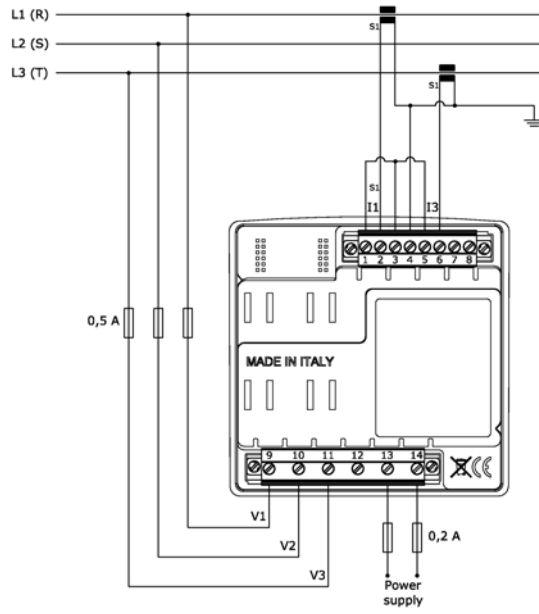

**Fig. 7: 3PH-BL**

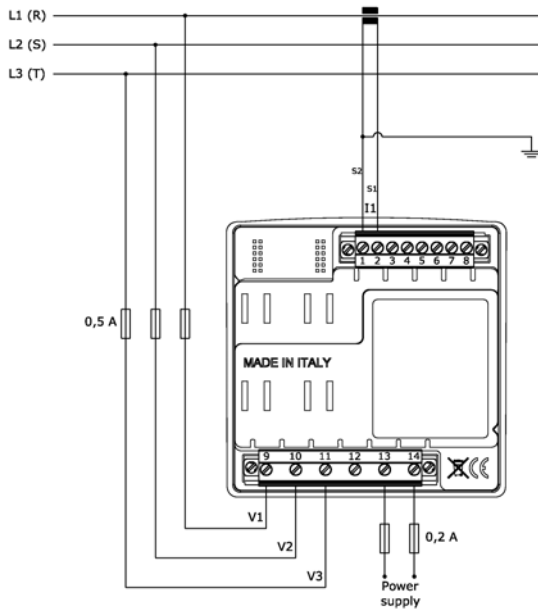

**Fig. 8: 2PH**

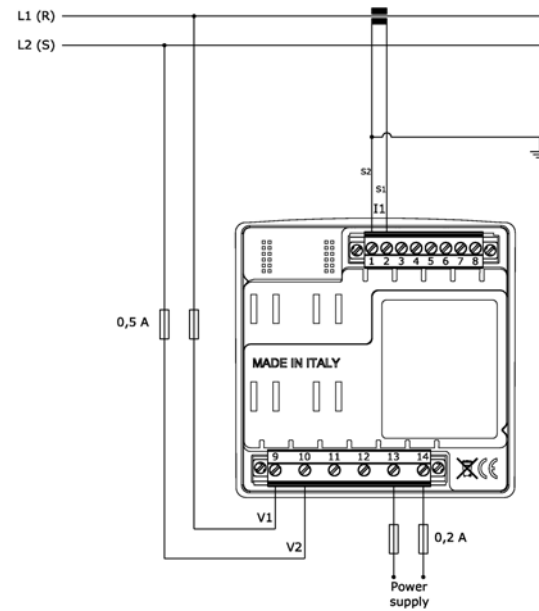

**Fig. 9: 1PH**

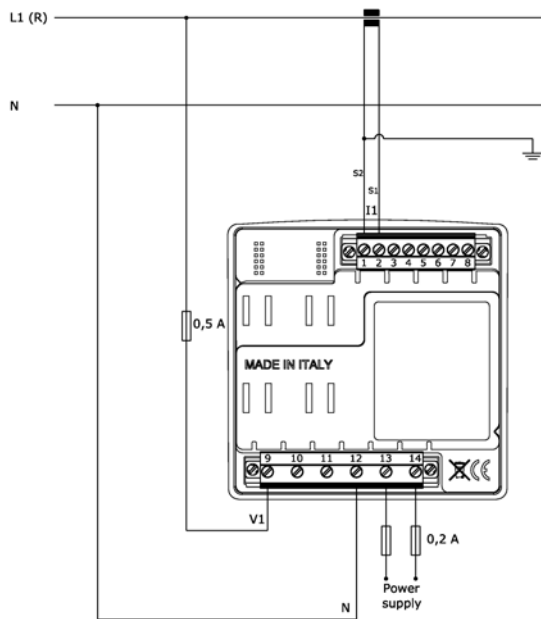

**Fig. 10: VT connection**

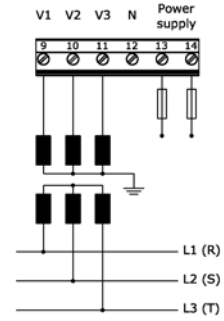

#### 4 - START-UP

Before using Polar Star for the very first time, you need to configure it correctly according to the installation and plant to which it has been connected.

When the installation is completed, switch on the control board to turn the instrument on.

At the start-up, the instrument will display the following presentation page for a few seconds:

Polar Star Top ← • Polar Star model (BASE or TOP model);  
 Rel. 3.14 ← • the software version;  
 Opt.1 - RS485 ← • the option which may be present in slot 1;  
 Opt.2 - ALM/Dig.Output ← • the option which may be present in slot 2;  
 S/N 2909-0025 ← • the device serial number.

Afterwards, the instrument will show the voltage measurement menu.

#### 4.1 - User Interface

Polar Star is structured into MENUS. More specifically:

- Set-up menus;
- Measurement menus.

##### 4.1.1 - Set-up and Measurement Pages

A typical SET-UP page consists of:

Connections Set-up ← • a heading containing the name of the screen;  
 Net Type: 3PH ← • an area containing the fields which can be selected with the **cursor** and edited, if necessary.

SET-UP PAGE

A typical MEASUREMENT screen consists of:

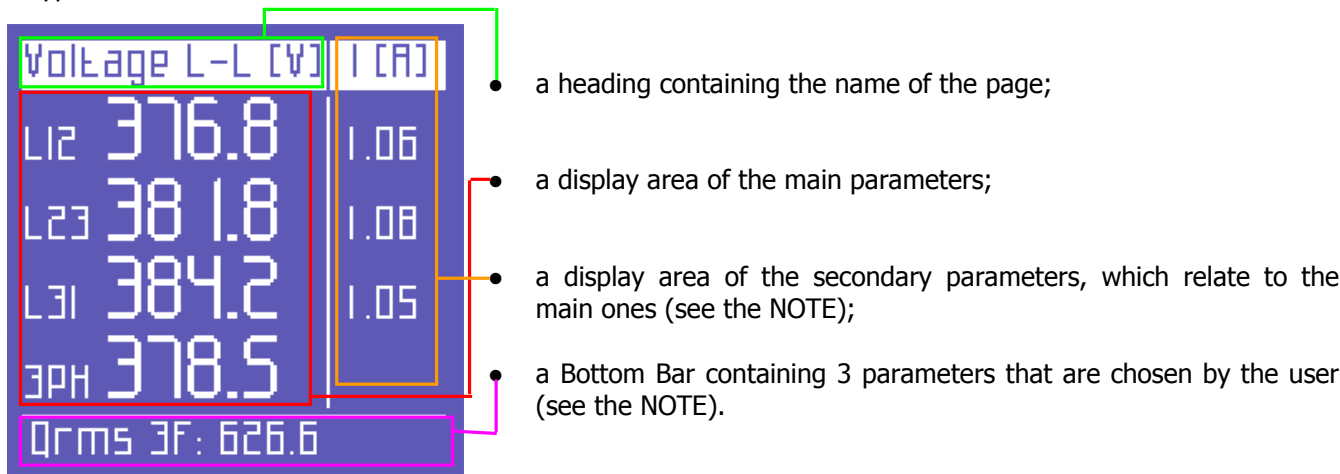





**NOTE:** according to the type of menu, the secondary parameter area and/or the Bottom Bar might not be displayed.

#### 4.1.2 - Keypad



Four keys allow users to navigate through the Menus and, where necessary, to edit the parameters.



The keypad is very easy to use - for further information, please refer to the set-up flowcharts (Sect. 4.2) and the measurement flowcharts (Sect. 5.2). Its functioning may be summarised as follows:

-  - scrolling of measurement or set-up menus.
-  - selection of a parameter to edit in the set-up;  
- access to a measurement sub-page or sub-menu (e.g. for enabling the scrolling of the harmonic histogram or the alarms). In this case, when you press this key, the message **ENTER** will be displayed at the lower right corner of the screen.
-  - upwards scrolling of the pages of a measurement menu;  
- cursor up-movement in the set-up pages;  
- increase of a value selected in the set-up.
-  - downwards scrolling of the pages of a measurement menu;  
- cursor down-movement in the set-up pages;  
- decrease of a value selected in the set-up.

By pressing more keys simultaneously, you can access other functions:



-  - entering/quitting the set-up menu;
-  - only from the Voltage menu pages, you can perform the electrical connection test to the plant;
-  - only from the connection set-up page, hold these keys pressed for about 5 seconds in order to access the insert/change password for the set-up menus.

## 4.2 - Programming and Set-up

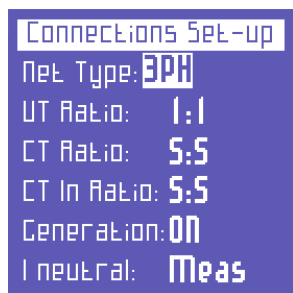
Press the keys  simultaneously to  access the instrument configuration menus.



From here, press the keys  and  to move the cursor on the parameter to be configured.

By pressing  the cursor will start blinking. Now press the keys  and  to edit the values highlighted by the cursor.

Press again  to confirm the value. The cursor will stop blinking.

Press  to scroll the set-up pages, as indicated in the flowchart below.

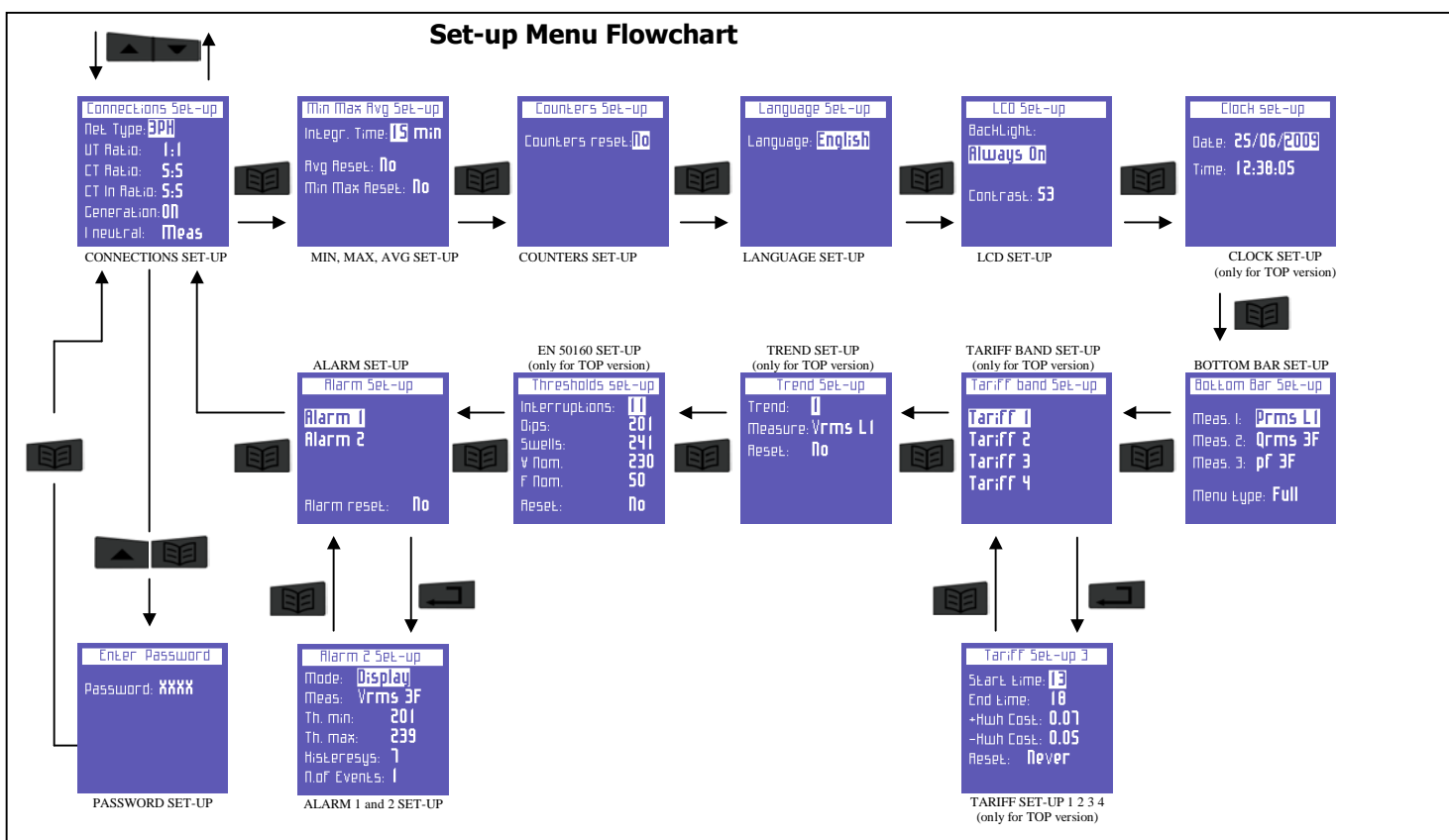

**NOTE:** set-up pages relating to the options are automatically introduced in plug and play mode when optional devices are connected. For further information, please refer to the relevant option manuals.

To quit the SET-UP menu, press simultaneously the keys  from any page.

### 4.2.1 - Connections Set-up

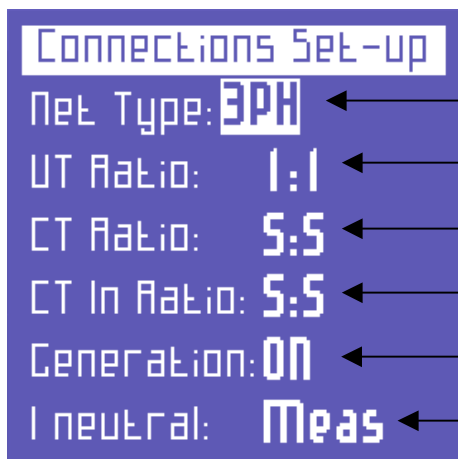

In this menu you can set:

- the type of electrical network to which the instrument is connected;
- the Voltage Transformation (VT) ratio;
- the Current Transformation (CT) ratio for L1, L2 and L3;
- the Current Transformation ratio for the I neutral;
- the activation or deactivation of measurement of generated powers and energies;
- actually measuring the I neutral or, in the absence of CT on In, calculating it from the other currents.

#### 4.2.1.1 - Electrical Connection Set-up

In the **CONNECTIONS SET-UP** Menu, to set the type of connection, place the cursor on **NET TYPE** and choose one of the following options (for further information, please refer to section 3.1.2):

- **3PH+N-BL** = balanced three-phase system with neutral (Fig. 4)
- **3PH-BL** = balanced three-phase system without neutral (Fig. 7)
- **3PH** = unbalanced three-phase system without neutral (Fig. 5 - 6)
- **3PH+N** = unbalanced three-phase system with neutral (Fig. 3)
- **2PH** = two-phase system (Fig. 8)
- **1PH** = single-phase system (Fig. 9)

#### 4.2.1.2 - Voltage Ratio Set-up (VT)

When you need to connect a Voltage Transformer, or when you need to measure voltages higher than 600Vac, you need to set the relevant transformation ratio.

In order to do so, go to the **CONNECTIONS SET-UP** page, place the cursor on **VT** and edit the values (from 1 to 60000).

#### 4.2.1.3 - Current Ratio Set-up (CT)

In order to set the current ratio of the CTs connected, go to the **CONNECTIONS SET-UP** page, place the cursor on **CT** and edit the values (from 1 to 60000).

#### 4.2.1.4 - Current Ratio Set-up of I Neutral

In order to set the current ratio of the CT on the 4<sup>th</sup> current channel, go to the **CONNECTIONS SET-UP** page, place the cursor on **CT IN** and edit the values (from 1 to 60000).

#### 4.2.1.5 - Cogeneration Set-up

You can set Polar Star also when you need to measure the generated powers and energies, if any.

In order to do so, go to the **CONNECTIONS SET-UP** page, place the cursor on **GENERATION** and select **ON**. By selecting **OFF**, the instrument will stop counting the energy generated, *which will always be considered as absorbed energy*.

**NOTE:** by switching from Generation ON to Generation OFF, *the generated energy counters will not be reset*.

#### 4.2.1.6 - Neutral Current Set-up

In unbalanced systems with neutral, you may decide whether to perform a real measurement of the In by using a dedicated CT or calculate it via Polar Star according to the phase currents actually measured.

In order to measure the In, go to the **CONNECTIONS SET-UP** page, place the cursor on **I NEUTRAL** and select **MEAS**.

In order to make just one calculation of the In, deriving it from I1, I2 and I3, select **CALC**.



## 4.2.2 - Minimum, Maximum and Average Set-up



Through this menu it is possible to:

- set the integration time, viz the lapse of time on which the average values and peaks are calculated (maximum demand);
- reset average values and maximum demands;
- reset minimum peaks and instant maximum values.

NB. After installing and switching on the instrument, we recommend performing a reset of average, minimum and maximum values.

### 4.2.2.1 - Integration Time Set-up

To set the integration time, go to the **MIN MAX AVG SET-UP** page, place the cursor on **INTEGR. TIME** and set the desired number expressed in minutes (default value: 15 min).

### 4.2.2.2 - Average Values and Maximum Demand Reset

To reset average values and max. demands, go to the **MIN MAX AVG SET-UP** page, place the cursor on **AVG RESET** and set **YES**.

### 4.2.2.3 - Minimum and Maximum Reset

To reset instant minimum and maximum values, go to the **MIN MAX AVG SET-UP** page, place the cursor on **MIN MAX RESET** and set **YES**.



## 4.2.3 - Counters Reset

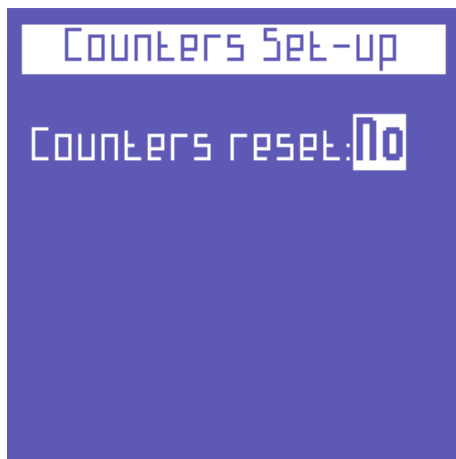

To reset absorbed and generated energy counters, go to the **COUNTERS SET-UP** page and select **YES** on **COUNTERS RESET**.

**NB. To reset the tariff counters, please refer to section 4.2.8.1**



## 4.2.4 - Language Set-up



In order to set the language, go to the **LANGUAGE SET-UP** page and select one of the following languages:

- **ENGLISH**
- **ITALIANO**
- **ESPAÑOL**
- **FRANCAIS**
- **DEUTSCH**



#### 4.2.5 - LCD Set-up

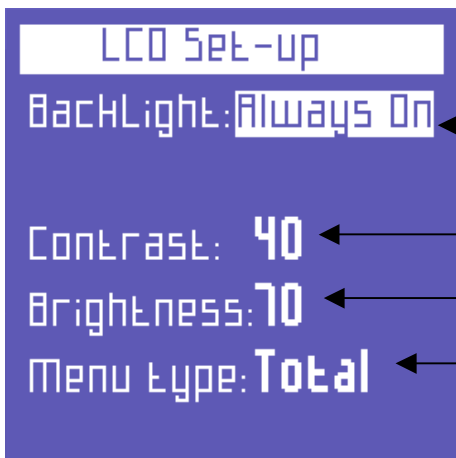

In the **LCD SET-UP** page, it is possible to set:

- the display backlight;
- the LCD contrast level;
- the display brightness;
- the menu type.

##### 4.2.5.1 - Backlight Set-up

You can choose different backlight settings in the **LCD SET-UP** page by placing the cursor on **BACKLIGHT** and selecting:

- **ALWAYS ON;**
- **15 SEC OFF-TIME** (when pressing a button, the brightness diminishes after 15 seconds);
- **1 MIN OFF-TIME** (when pressing a button, the brightness diminishes after 1 minute).

The LCD efficiency in time depends on the number of lighting hours and the brightness level used (Sect. 4.2.5.2). Unless there are particular needs, we recommend keeping a brightness higher than 70, with ALWAYS ON backlight.

**NOTE:** the display turns on automatically if a video alarm goes on (see Sect. 4.2.11.1).

##### 4.2.5.2 - Contrast and Brightness Set-up

From the **LCD SET-UP** page it is possible to set the display contrast and brightness so as to increase or decrease the view efficiency and adjust the instrument according to the environmental conditions.

In order to do so, place the cursor on **CONTRAST** or **BRIGHTNESS**, then increase or decrease these parameters by increasing or decreasing the relevant values.

##### 4.2.5.3 - Menu Set-up *(irrelevant menu for the BASE version)*

Polar Star is very easy to use. Nevertheless, it is equipped with all the measures and functions a similar device can have. If the user needs only a part of these functions or measures, all the others may then be superfluous.

For a still easier functioning of the device, two types of menus have been introduced:

- the **COMPLETE** menu, consisting of all the existing screens (see Sect. 5);
- the **PARTIAL** menu, which does not include some measurements menus (Tariff, Trend, EN50160 and Alarm Log menus) and makes the consultation less complete but much quicker.

**NOTE:** the partial menu only affects the display mode. Data are always stored and when you switch to the complete menu, you will immediately see the analyses performed in the previously deactivated menus.



#### 4.2.6 - Clock Set-up *(only for TOP version)*



In the **CLOCK SET-UP** page it is possible to set date and time:

The date format is DD/MM/YYYY



### 4.2.7 - Bottom Bar Set-up

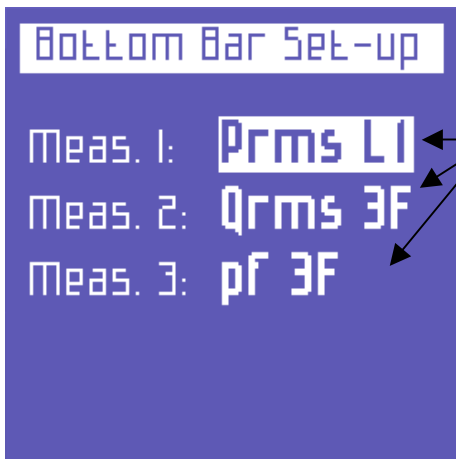

In the **BOTTOM BAR SET-UP** page it is possible to set:

the 3 parameters (among 53 possibilities in total) to be displayed in the bottom part of the measurement screens. You may choose three of the following:

Vrms 3F, Vrms L1, Vrms L2, Vrms L3, Irms 3F, Irms L1, Irms L2, Irms L3, Prms 3F, Prms L1, Prms L2, Prms L3, Qrms 3F, Qrms L1, Qrms L2, Qrms L3, Srms 3F, Srms L1, Srms L2, Srms L3, pf 3F", pf L1, pf L2, pf L3, thdv 3F, thdv L1, thdv L2, thdv L3, thdi 3F, thdi L1, thdi L2, thdi L3, KWh+3F, KWh L1, KWh L2, KWh L3, KVArh+3F, KVArhL1, KVArhL2, KVArhL3, KWh-3F, KVArh3F, KWh+F1, KWh+F2, KWh+F3, KWh+F4, Clock, Freq, In, Unbal, n.dip, n.swell, n.int.

**NOTE:** if you need to display only one quantity, set the same parameter on the 3 positions.



### 4.2.8 - Tariff Band Set-up *(only for TOP version)*



From the **TARIFF BAND SET-UP** menu, choose one of these 4 tariff bands by using the cursor.

When the choice has been made, press  to access the relevant configuration and reset sub-menu.



#### 4.2.8.1 - Tariff Configuration and Reset *(only for TOP version)*

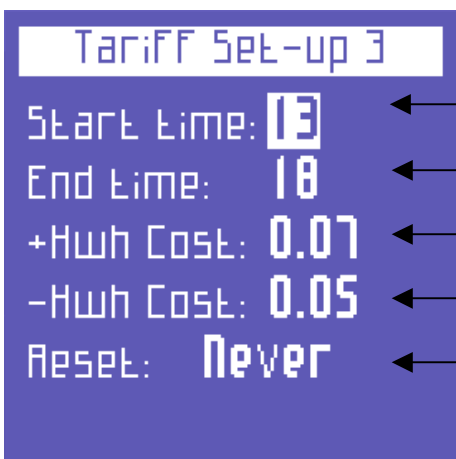

According to the tariff chosen, it is possible to set:

- the start time (with 15 minute intervals);
- the end time (with 15 minute intervals);
- the cost of the kWh spent in your preferred currency;
- the income of the kWh generated in your preferred currency;
- the reset of previous counts:  
**NEVER - 1 MONTH - 2 MONTHS - 3 MONTHS**

**NOTE:** do not overlap the times of tariff bands. When you modify the time of a tariff, always check that it does not interfere with the time of another tariff.

To set 24:00, select 0:00.

Press



to go back to the **TARIFF BAND SET-UP** menu.



### 4.2.9 - Trend Set-up and Reset *(only for TOP version)*

In the **TREND SET-UP** page, you can select the 5 quantities for displaying the time progresses

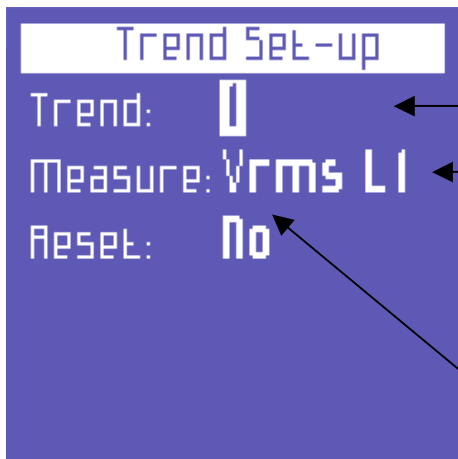

- First select a number from 1 to 5
- and then choose one of the following parameters to monitor:  
 Vrms 3F, Vrms L1, Vrms L2, Vrms L3, Irms 3F, Irms L1, Irms L2, Irms L3, Prms 3F, Prms L1, Prms L2, Prms L3, Qrms 3F, Qrms L1, Qrms L2, Qrms L3, Srms 3F, Srms L1, Srms L2, Srms L3, pf 3F", pf L1, pf L2, pf L3, thdv 3F, thdv L1, thdv L2, thdv L3, thdi 3F, thdi L1, thdi L2, thdi L3, Freq,In,Unbal, H1..H31 (VL1), H1..H31 (VL2), H1..H31 (VL3), H1..H31 (IL1), H1..H31 (IL2), H1..H31 (IL3).
- If you set **YES** on **RESET**, all the trends are reset

NB. After installing and switching on the instrument, we recommend performing a reset of the trend-relating storage.



### 4.2.10 - EN 50160 Set-up and Reset *(only for TOP version)*

As indicated in the EN 50160 standard, the phenomena of disruption of voltage (overvoltages, losses, blackouts, etc.) do not have standard values through which the electric energy quality may be assessed. Therefore, according to the type of installation, production, connected equipment, etc., it is the user who must evaluate whether the disruption of voltage on the plant is dangerous or not. In the **THRESHOLDS SET-UP** page, it is possible to set the values for the correct performance of the 50160 TEST (sect. 5.1.10), viz the assessment of the plant Power Quality.

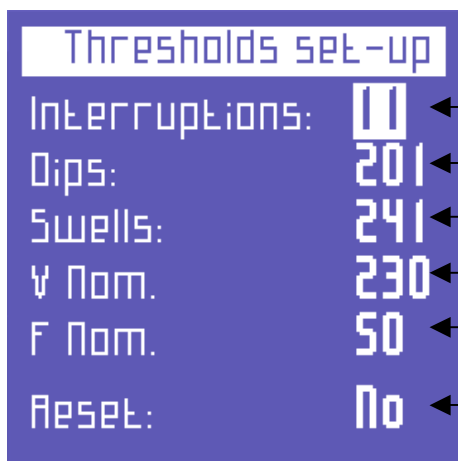

- More specifically, it is possible to set:
- the Vrms value below which the blackout is defined;
  - the Vrms value below which a Dip is present;
  - the Vrms value above which a Swell is present;
  - the nominal voltage;
  - the nominal frequency;
  - the reset of the storage relating to all network disruptions which have already been recorded.

NB. After installing and switching on the instrument, we recommend performing a reset of the EN50160 test-relating storage.



### 4.2.11 - Alarm Set-up and Reset

Polar Star provides the setting and configuration of 2 alarms.

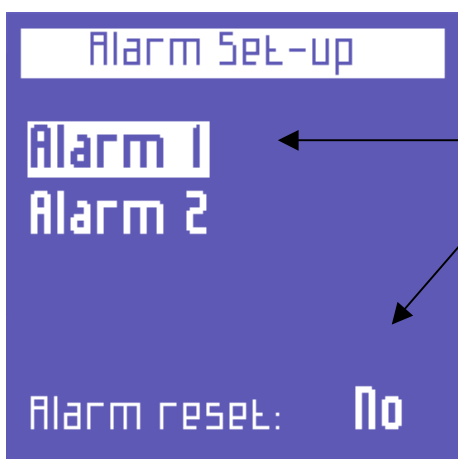

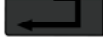
- In the **ALARM SET-UP** page, press  on one of the 2 alarms to access the relevant configuration sub-menu.
- If you set **ALARM RESET** on **YES**, all the stored alarms which can be viewed in the **ALARM LOG** measurement menu are reset.



### 4.2.11.1 - Alarm Configuration

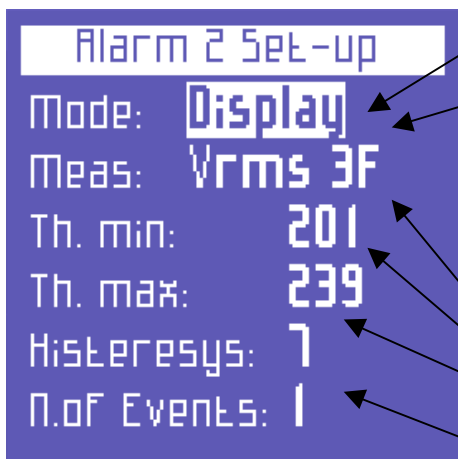

- After entering the alarm 1 or 2 configuration sub-menu, you may disable it by setting **OFF** or activating it by setting **DISPLAY**.
- Choose the measure on which you wish to introduce the alarm among the following 34 options:  
Vrms 3F, Vrms L1, Vrms L2, Vrms L3, Irms 3F, Irms L1, Irms L2, Irms L3, Prms 3F, Prms L1, Prms L2, Prms L3, Qrms 3F, Qrms L1, Qrms L2, Qrms L3, Srms 3F, Srms L1, Srms L2, Srms L3, pf 3F, pf L1, pf L2, pf L3, thdv 3F, thdv L1, thdv L2, thdv L3, thdi 3F, thdi L1, thdi L2, thdi L3, Freq, In, Unbal.
- Set the minimum alarm value.
- Set the maximum alarm value.
- Set the hysteresis percentage, which is valid for both minimum and maximum thresholds.
- Set the number of events occurred after which the alarm should really go off.

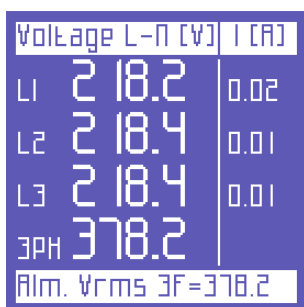

If one of the set alarms goes off, this will be highlighted in the measurement page bottom bar.

**NOTE:** you can use the dedicated option to connect the alarm to a relay. For further information, please refer to the option manual ALM - DIGITAL OUTPUT.



Press  to go back to the **ALARM SET-UP** menu.



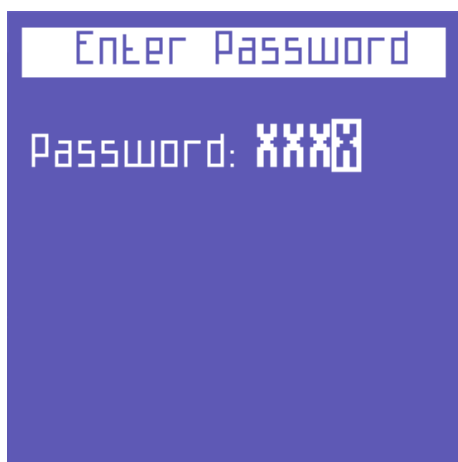



### 4.2.12 - Set-up Protection Password



Polar Star allows you to protect all set-up configurations, counters reset and other sensitive data.

From the CONNECTIONS SET-UP menu, hold the keys  and  pressed for about 5 seconds to access the Enter Password page.



Press the key  to select the digit to edit. Then, press the keys  and  to type the 4-digit code. When you go back to the CONNECTIONS SET-UP page via the key , this code will be the new protection password.

You will therefore be requested to enter this code every time you try to access the set-up menus.

## 5 - INSTRUMENT USE AND CONSULTATION

### 5.1 – Connections Check

When the instrument is connected, switched on and configured, you may check the connection to the electric system, if the PF is included in the one showed on the screen.

By pressing  and  simultaneously, the above-mentioned test will start and the relevant outcomes will be displayed.

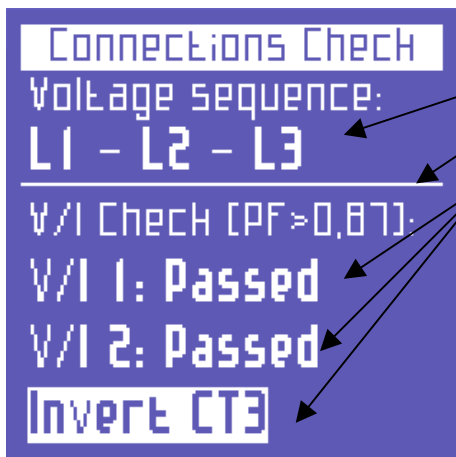

- Voltage phase sequence
- Threshold of the PF measured for a correct analysis
- Check of the correspondence between voltage and current of each phase and possible error message:

PASSED = Connection is correct

INVERT CT= You need to invert the two input current leads

FAIL = Test failed because there is no correspondence between voltage and current, or because the PF is lower than the threshold displayed

To quit the connection test page, press



### 5.2 – Measurement Menu Scrolling

Press the key  to scroll all the measurement menus. When you switch from one menu to another, the instrument always directs you to the first page of the selected menu.

Press the keys  and  to scroll the pages of each menu.

Some pages provide access to internal sub-functions by pressing .

Below are the measurement menu flowcharts

**NOTE:** menus or single pages might not be displayed or edited, depending on the model (BASE or TOP), on the type of menu (COMPLETE or PARTIAL) and/or on the type of electrical connection (e.g. if you set the single-phase connection, the screens related to three-phase data will be deleted and the structure of many pages may change).

### MEASUREMENT MENU Flowchart in **THREE-PHASE** Connection.

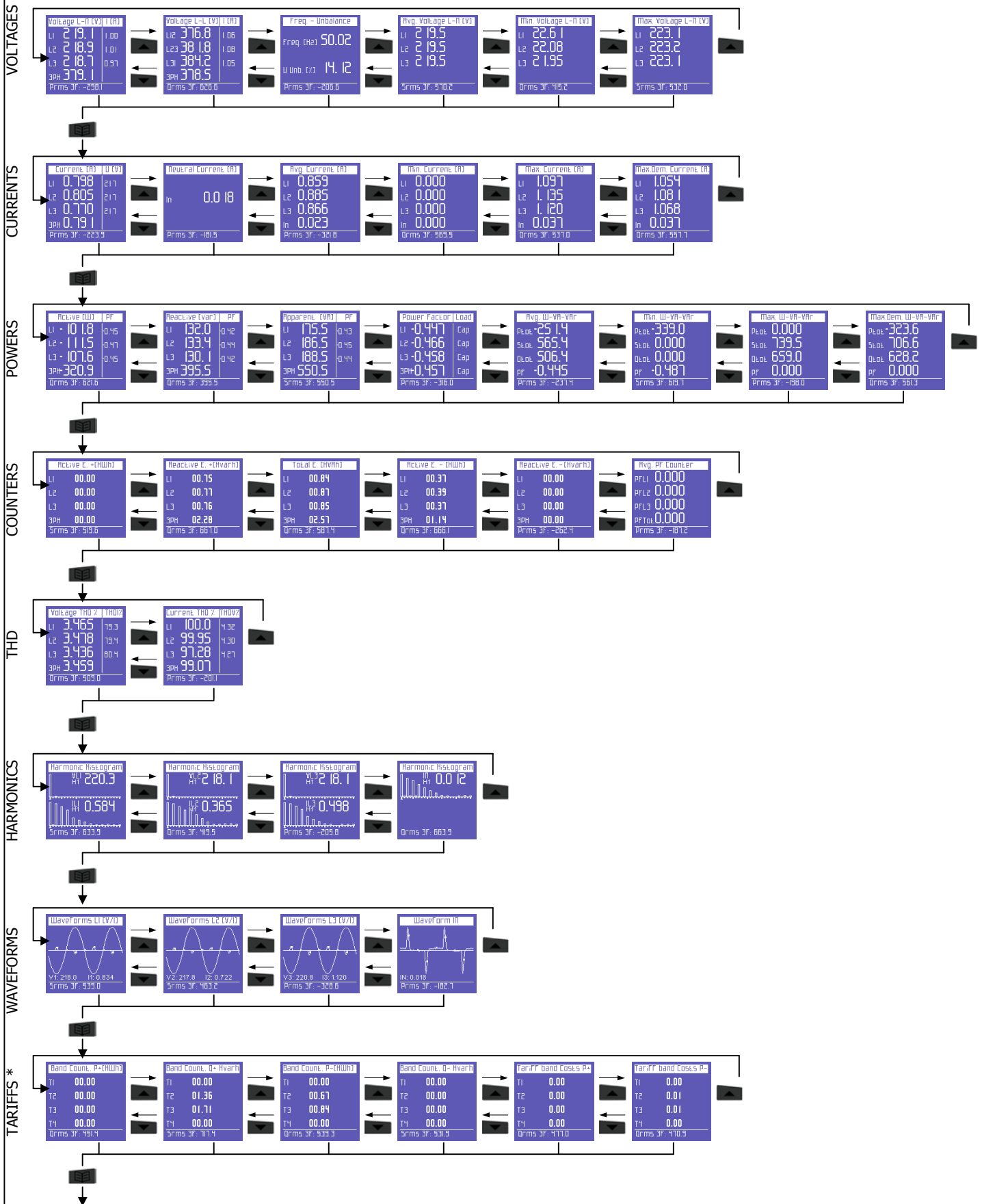

\*Only for TOP version with COMPLETE menu

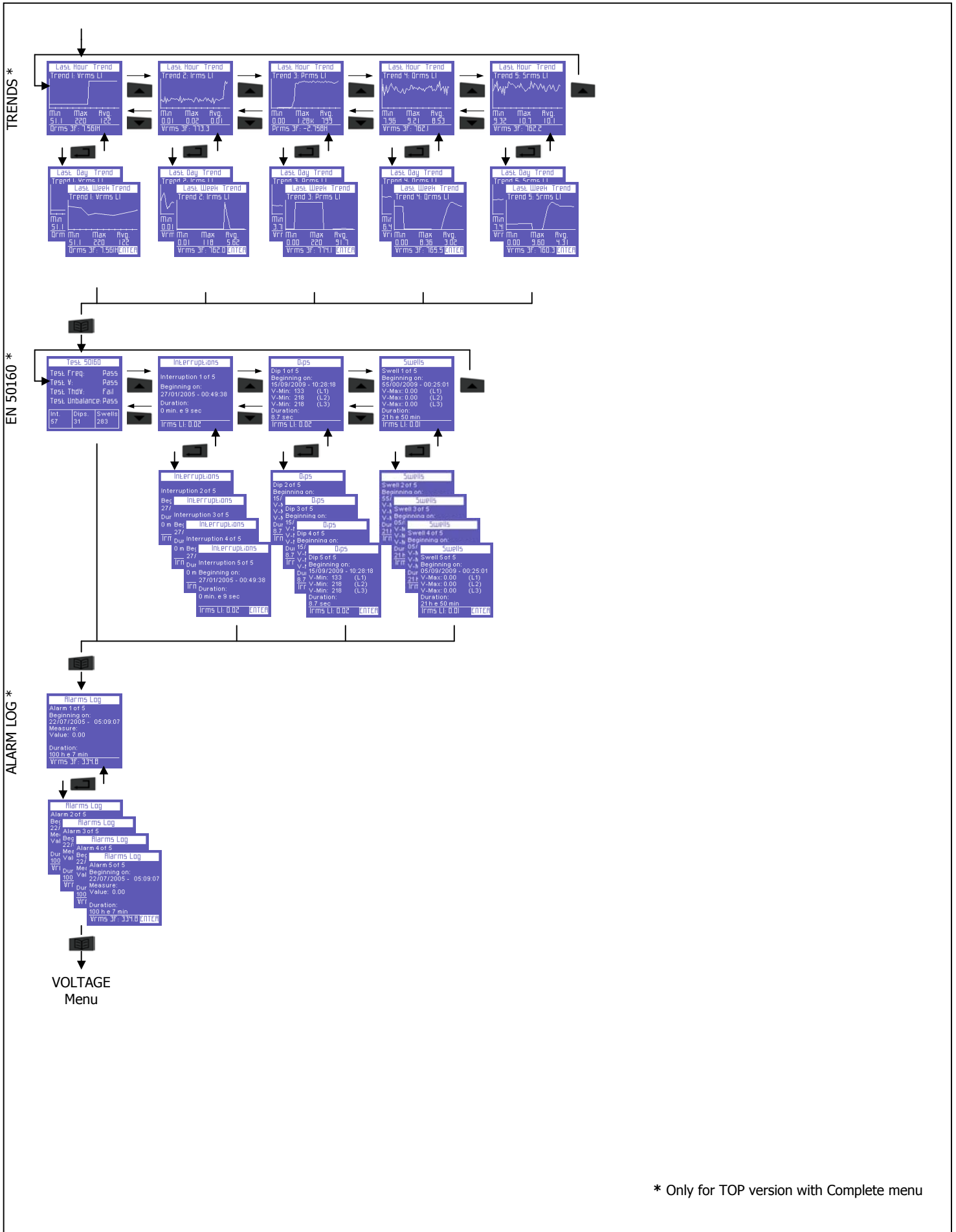

\* Only for TOP version with Complete menu

**MEASUREMENT MENU Flowchart in SINGLE-PHASE Connection.**

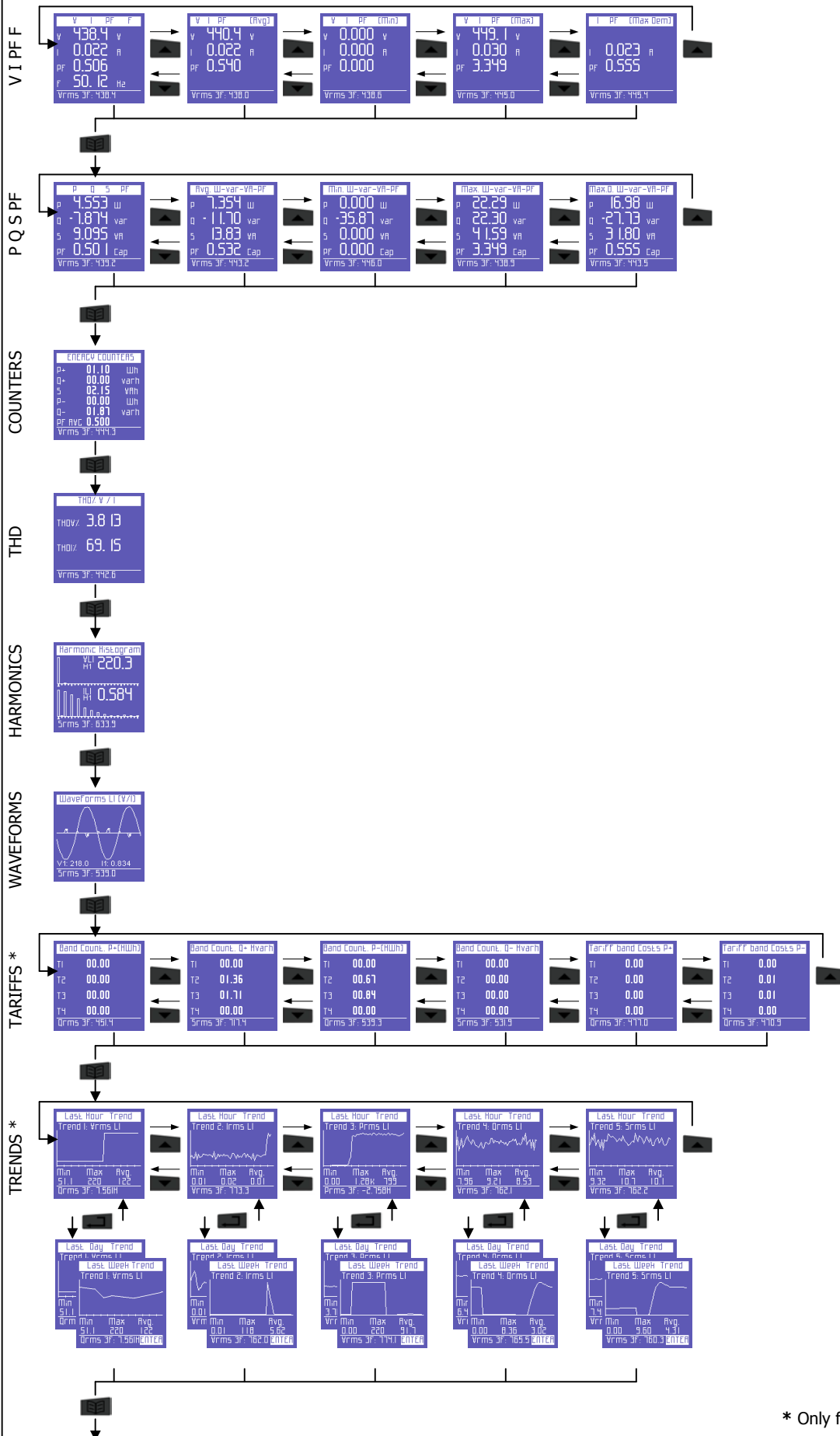

\* Only for TOP version with Complete menu

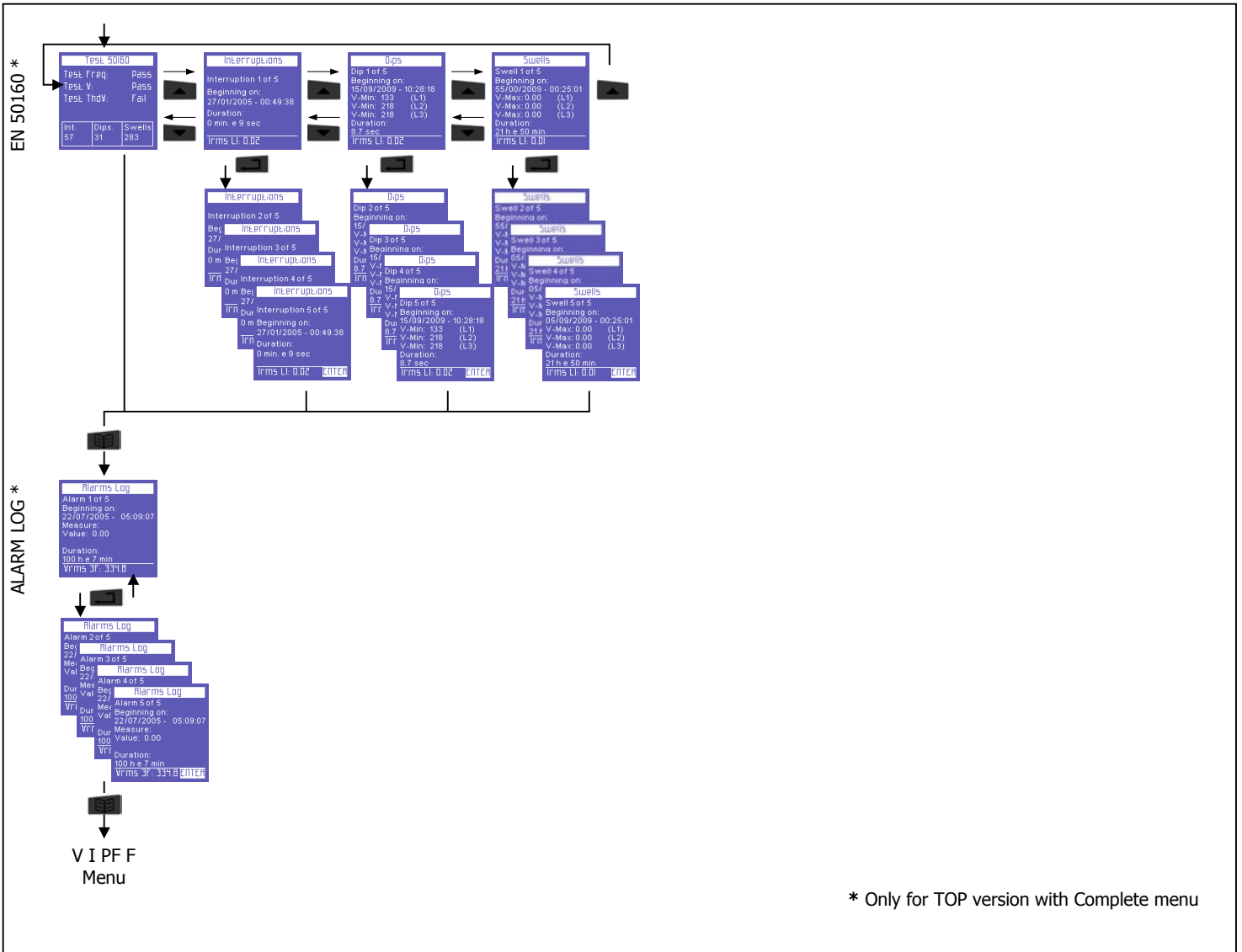

### 5.3 - Three-phase or Two-phase Connection Menu

At the start-up or when quitting the set-up menu, Polar Star directs you to the first page of the voltage menu. As you can see from the flowcharts, menus have a circular structure: when you reach the last menu, if you keep scrolling, you are re-directed to the first menu.

Depending on the type of set connection, different situations may occur.

#### 5.3.1 - Voltage Menu

Voltage L-N [V]		I [A]
L1	219.1	1.00
L2	218.9	1.01
L3	218.7	0.97
3PH	379.1	
Prms 3F: -298.1		

Let us consider the following connections: 3PH+N (unbalanced three-phase with neutral), 3PH+N-BL (balanced three-phase with neutral) and 2PH (two-phase). If one of these connections is set, the first page will show the phase/neutral voltages, the corresponding phase currents and the three-phase voltage.

**NOTE:** if other electrical connections without neutral are set, this page will not be displayed.

Voltage L-L [V]		I [A]
L12	376.8	1.06
L23	381.8	1.08
L31	384.2	1.05
3PH	378.5	
Prms 3F: 626.6		

Line voltages and relevant phase currents

Freq. - Unbalance	
Freq. [Hz]	50.02
U Unb. [%]	14.12
Prms 3F: -206.6	

Frequency (measured on L1) and unbalance.

**NOTE:** in a three-phase system, the unbalance value is a parameter that indicates a condition in which the phase voltage effective values or the phase angles between consecutive phases are not the same. This parameter is one of those values which indicate the electric energy quality. The lower the percentage value, the better the voltage quality.

Avg. Voltage L-N [V]	
L1	219.5
L2	219.5
L3	219.5
Prms 3F: 570.2	

Voltage average values – calculation is made on the basis of the integration time. Values can be reset as indicated in sect. 4.2.2

Min. Voltage L-N [V]	
L1	22.61
L2	22.08
L3	21.95
Prms 3F: 415.2	

Minimum instant voltage values. The values recorded can be reset as indicated in sect. 4.2.2.3

Max. Voltage L-N [V]	
L1	223.1
L2	223.2
L3	223.1
Prms 3F: 532.0	

Maximum instant voltage values. The values recorded can be reset as indicated in sect. 4.2.2.3



### 5.3.2 - Current Menu

Current [A]		U [V]
L1	0.798	217
L2	0.805	217
L3	0.770	217
3PH	0.791	
Prms 3F: -223.9		

The first page of this menu shows the currents for each phase as well as the three- or two-phase current

By scrolling the pages of this menu, as indicated in section 5, the following pages will be displayed.



Neutral Current [A]	
In	0.018
Prms 3F: -181.5	

Neutral current (also known as 4<sup>th</sup> current channel).

**NOTE:** if the instrument is not set to 3PH+N or 3PH+N-BL mode (unbalanced or balanced three-phase with neutral - see sect. 4.2.1.1), this quantity will always be 0.000



Avg. Current [A]	
L1	0.859
L2	0.885
L3	0.866
In	0.023
Prms 3F: -321.8	

Current average values for each phase – calculation is made on the basis of the integration time. Values can be reset as indicated in sect. 4.2.2



Min. Current [A]	
L1	0.000
L2	0.000
L3	0.000
In	0.000
Qrms 3F: 569.5	

Minimum instant current values for each phase. The values recorded can be reset as indicated in sect. 4.2.2.3



Max. Current [A]	
L1	1.097
L2	1.135
L3	1.120
In	0.037
Qrms 3F: 537.0	

Maximum instant current values for each phase. The values recorded can be reset as indicated in sect. 4.2.2.3



Max. Dem. Current [A]	
L1	1.054
L2	1.081
L3	1.068
In	0.037
Qrms 3F: 557.7	

Peak loads, i.e. the highest current average values – calculation is made on the basis of the integration time. Values can be reset as indicated in sect. 4.2.2.2



### 5.3.3 - Power Menu

Active [W]		PF
L1	-101.8	-0.45
L2	-111.5	-0.47
L3	-107.6	-0.45
3PH	-320.9	
Prms 3F: 621.6		

The first page of this menu shows the active powers (W) of each phase and three- or two-phase connections, with the relevant PF values.

N.B. By convention, the generated active power is indicated as negative.

By scrolling the pages, as indicated in section 5, the following pages will therefore be displayed.



Reactive [var]		PF
L1	132.0	-0.42
L2	133.4	-0.44
L3	130.1	-0.42
3PH	395.5	
Prms 3F: 395.5		

Reactive powers (Var) of each phase and three- or two-phase connections, with the relevant PF values.

N.B. By convention, the capacitive reactive power is indicated as negative.



Apparent [VA]		PF
L1	175.5	-0.43
L2	186.5	-0.45
L3	188.5	-0.44
3PH	550.5	
Prms 3F: 550.5		

Apparent powers (VA) of each phase and three-phase or two-phase connections, with the relevant PF values.



Power Factor	Load
L1 -0.477	Cap
L2 -0.466	Cap
L3 -0.458	Cap
3PH -0.457	Cap
Prms 3F: -316.0	

The PF values for each phase and three- or two-phase connections, with the relevant type (Ind = inductive load; Cap = capacitive load)

NB. The PF parameter is always positive. By convention, it is indicated as negative when the active power is generated and not absorbed.



Avg. W-VAR-VAR	
PtOt	251.4
StOt	565.4
QtOt	506.4
PF	-0.445
Prms 3F: -237.4	

Average values of total powers and PF – calculation is made on the basis of the integration time. Values can be reset as indicated in sect. 4.2.2



Min. W-VAR-VAR	
PtOt	339.0
StOt	0.000
QtOt	0.000
PF	-0.487
Prms 3F: 619.7	

Minimum instant values of total powers and PF. The values can be reset as indicated in sect. 4.2.2.3



Max. W-VAr-VAr	
Pt.Ot.	0.000
St.Ot.	739.5
Qt.Ot.	659.0
PF	0.000
Prms 3F: -198.0	

Maximum instant values of total powers and PF. The values can be reset as indicated in sect. 4.2.2.3



Max.Oem. W-VAr-VAr	
Pt.Ot.	-323.6
St.Ot.	706.6
Qt.Ot.	628.2
PF	0.000
Qrms 3F: 561.3	

Peak loads and relevant PF, i.e. the highest average powers – calculation is made on the basis of the integration time. Values can be reset as indicated in sect. 4.2.2.2

### 5.3.4 - Counters Menu

Active E. +(kWh)	
L1	00.00
L2	00.00
L3	00.00
3PH	00.00
Srms 3F: 519.6	

The first page of this menu shows the counters of the active energy **absorbed** (+kWh) by each phase and three- or two-phase connections.

By scrolling the pages, as indicated in section 5, the following pages will therefore be displayed.



Reactive E. +(kVarh)	
L1	00.75
L2	00.77
L3	00.76
3PH	02.28
Qrms 3F: 667.0	

The counters of the reactive energy **absorbed** (+kVarh) by each phase and three- or two-phase connections



Total E. (kVAh)	
L1	00.84
L2	00.87
L3	00.85
3PH	02.57
Qrms 3F: 587.4	

The counters of the apparent energy (kVAh) by each phase and three- or two-phase connections



Active E. -(kWh)	
L1	00.37
L2	00.39
L3	00.37
3PH	01.14
Qrms 3F: 666.1	

The counters of the active energy **generated** (-kWh) by each phase and three- or two-phase connections

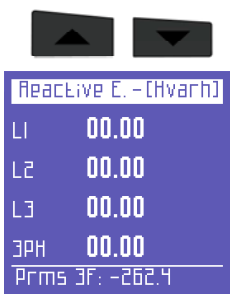

The counters of the reactive energy **generated** (-kVarh) by each phase and three- or two-phase connections

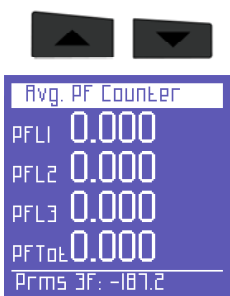

The average values of PFs calculated as a kWh/kVAh ratio – only the real part of the counters is taken into account. The decimal part is not considered

### 5.3.5 - THD Menu

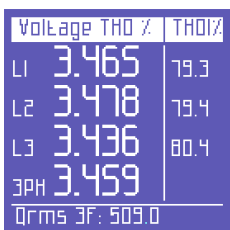

The first page of this menu shows the voltage THD% (Total Harmonics Distortion) on each phase and three- or two-phase connections as well as the relevant phase currents.

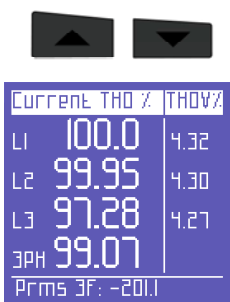

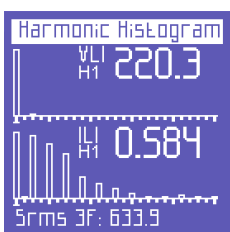

The next page shows the current THD% values of each phase and three- or two-phase connections, as well as the relevant phase voltages.

### 5.3.6 - Harmonics Menu

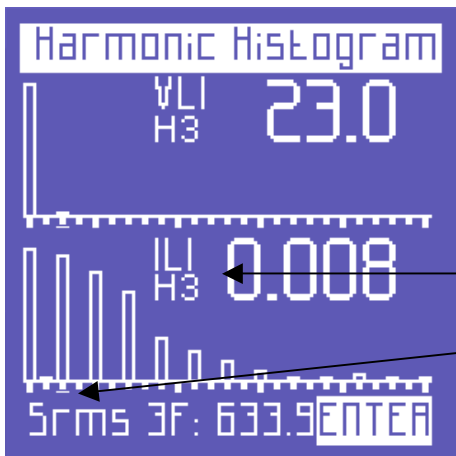

This menu allows you to see the voltage and current harmonic histograms of each phase and the neutral current.



From each page of this menu, by pressing , you can also access the function for selecting and scrolling the harmonics.

By pressing  and , it is possible to select each harmonic from the histogram and check the relevant values.

The selected harmonic is marked by:

- an order number;
- a cursor below the histogram.

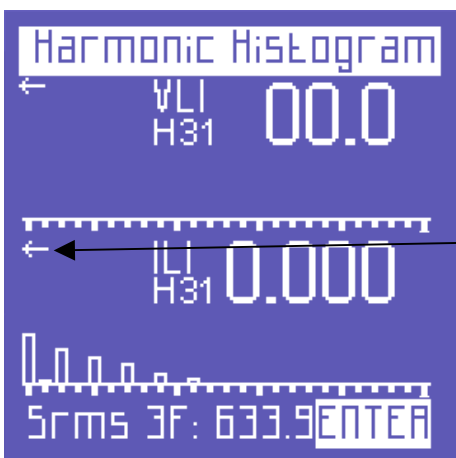

When you get past the 25<sup>th</sup> harmonic, which is the last one that can be seen on the screen, the page will change, showing the first harmonics of the spectrum on the left and the harmonics from 26<sup>th</sup> to 31<sup>st</sup> on the right.

• An arrow pointing to the left indicates that the screen virtually continues in that direction.

By pressing , it is possible to leaf the harmonic menu pages again.

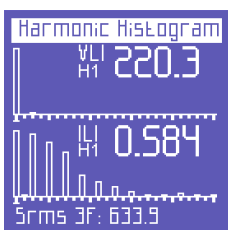

The first page of this menu shows the harmonic histograms of L1 voltage and current

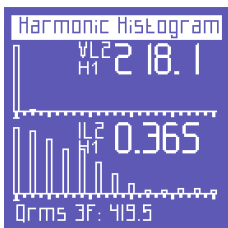

Harmonic histograms of L2 voltage and current

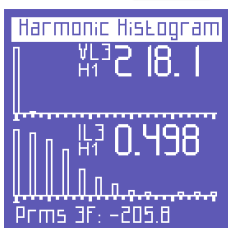

Harmonic histograms of L3 voltage and current

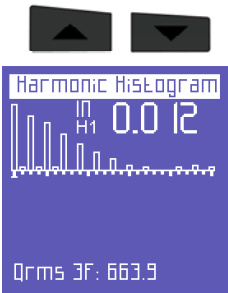

Harmonic histogram of neutral current.



### 5.3.7 - Waveform Menu

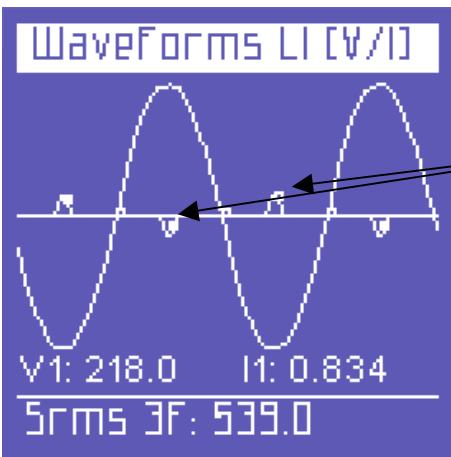

This menu shows the real-time waveforms and the relevant system voltage and current values.

**NOTE:** currents can be distinguished from voltages since their waveform is identified by a small square marker. The waveform width is only indicative and is automatically adjusted to the screen size.

The first page shows the waveforms of L1 voltage and current

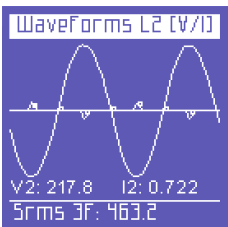

Waveforms of L2 voltage and current

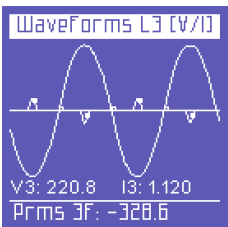

Waveforms of L3 voltage and current

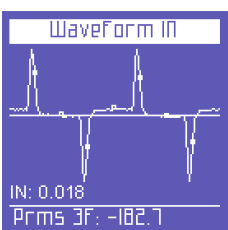

Waveform of neutral current.



### 5.3.8 - Tariff Band Menu (only for TOP model with Complete menu)

Band Count. P+(kWh)	
T1	00.00
T2	00.00
T3	00.00
T4	00.00
Qrms 3F: 451.4	

This menu shows the absorbed and/or generated energies as well as the relevant costs according to the set time periods (sect. 4.2.8)

The first page shows the kWh absorbed during the different time periods.



Band Count. Q+ kVarh	
T1	00.00
T2	01.36
T3	01.71
T4	00.00
Srms 3F: 717.4	

The kVarh absorbed during the different time periods



Band Count. P-(kWh)	
T1	00.00
T2	00.67
T3	00.84
T4	00.00
Qrms 3F: 539.3	

The kWh generated during the different time periods



Band Count. Q- kVarh	
T1	00.00
T2	00.00
T3	00.00
T4	00.00
Srms 3F: 531.9	

The kVarh generated during the different time periods



Tariff band Costs P+	
T1	0.00
T2	0.00
T3	0.00
T4	0.00
Qrms 3F: 477.0	

The cost expressed in the set currency unit (sect. 4.2.8.1) of the kWh absorbed during the different tariff bands





Tariff band Costs P-	
T1	0.00
T2	0.01
T3	0.01
T4	0.00
Qrms 3F: 470.9	

The income expressed in the set currency unit (sect. 4.2.8.1) of the kWh generated during the different tariff bands.



### 5.3.9 - Trend Menu (only for TOP model with Complete menu)

The trend menu allows you to view the time progress of 5 selectable measures (sect. 5.2.9).

The keys  and  allow you to select the measure to be displayed. For each measure, you can monitor its progress relating to:

- the latest hour;
- the latest day;
- the latest week;
- the latest month.

By pressing  and moving with the keys  and , you can display one of the 4 above-mentioned time references.

For each time period, minimum, maximum and average values are also displayed.



**5.3.10 - EN50160 Menu** (only for TOP model with Complete menu)

This menu allows you to monitor a number of main Power Quality parameters (energy quality).

Test 50160		
Test Freq:	Pass	
Test V:	Pass	
Test ThdV:	Fail	
Test Unbalance:	Pass	
Int.	Dips.	Swells
57	31	283

The first page shows the outcome of the EN50160 compliance test (reference standard for energy quality), according to the values set in the set-up page (sect. 4.2.10).

It is therefore assessed whether frequency, voltage, harmonic voltage distortion and unbalance fall within the standard range, according to the set nominal values.

Furthermore, a table shows the number of blackouts, voltage losses (Dips) and overvoltages (Swells) which occurred during monitoring.



Interruptions
Interruption 1 of 5
Beginning on: 27/01/2005 - 00:49:38
Duration: 0 min. e 9 sec
Irms LI: 0.02

These pages show the last 5 blackouts occurred, if any.

**NOTE:** EN50160 recommends defining blackouts as a simultaneous drop of all phase voltages below 5% of nominal V (see the set-up, sect. 4.2.10). Nevertheless, the user may decide to set a different threshold.

These events are identified by start time and duration.

When scrolling the EN50160 menu, the latest blackout occurred is automatically displayed.

In order to identify any other previous blackouts, press  and leaf the relevant

pages through the keys  and .



Dips
Dip 1 of 5
Beginning on: 15/09/2009 - 10:28:18
V-Min: 133 (L1)
V-Min: 218 (L2)
V-Min: 218 (L3)
Duration: 8.7 sec
Irms LI: 0.02

These pages show the last 5 voltage losses occurred, if any.

**NOTE:** EN50160 recommends defining dips as a drop of one or more phase voltages below 90% of nominal V (see the set-up, sect. 4.2.10). Nevertheless, the user may decide to set a different threshold.

These events are identified by start time, concerned phase(s) and duration of the event.

When scrolling the EN50160 menu, the latest dip occurred is automatically displayed.

To identify any other previous dips, press  and leaf the relevant pages through

the keys  and .



Swells
Swell 1 of 5
Beginning on: 55/00/2009 - 00:25:01
V-Max: 0.00 (L1)
V-Max: 0.00 (L2)
V-Max: 0.00 (L3)
Duration: 21 h e 50 min
Irms LI: 0.01

These pages show the last 5 overvoltages occurred, if any.

**NOTE:** EN50160 recommends defining swells as an increase of one or more phase voltages above 110% of nominal V (see the set-up, sect. 4.2.10). Nevertheless, the user may decide to set a different threshold.

These events are identified by start time, concerned phase(s) and duration of the event.

When scrolling the EN50160 menu, the latest swell occurred is automatically displayed.

In order to identify any other previous swells, press  and leaf the relevant pages

through the keys  and .

**5.3.11 - Alarm Log Menu** (only for TOP model with Complete menu)

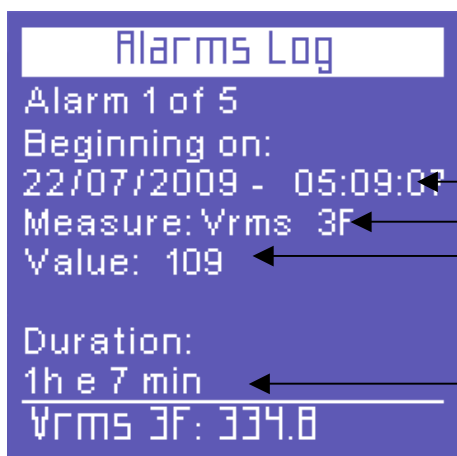

This menu stores and displays the last 5 alarms occurred (for their set-up, please refer to sect. 4.2.11).



The menu automatically directs you to the page of the latest alarm occurred.

Each alarm is identified by:

- start date and time;
- type of parameter of the set thresholds;
- value of the parameter that caused the alarm condition;
- duration of the event.

In order to identify the 4 previous alarms occurred (if any), press  and leaf the relevant pages through the keys  and .

NB. Alarms are stored and then displayed only at the end of the event, viz when the analysed parameter falls within the set values.

## 5.4 - Single-phase Connection Menu

### 5.4.1 - V I P F Menu

	V	I	PF	F
V	438.4	V		
I	0.022	A		
PF	0.506			
F	50.12	Hz		
Vrms 3F: 438.4				

The first page shows: voltage, current, PF and frequency.

By scrolling the other pages of this menu, as indicated in section 5, the following quantities are displayed.



	V	I	PF	[Avg]
V	440.4	V		
I	0.022	A		
PF	0.540			
Vrms 3F: 438.0				

Average values for voltage, current and PF – calculation is made on the basis of the integration time. Values can be reset as indicated in sect. 4.2.2



	V	I	PF	[Min]
V	0.000	V		
I	0.000	A		
PF	0.000			
Vrms 3F: 438.6				

Minimum instant values for voltage, current and PF. The values can be reset as indicated in sect. 4.2.2.3



	V	I	PF	[Max]
V	449.1	V		
I	0.030	A		
PF	3.349			
Vrms 3F: 445.0				

Maximum instant values for voltage, current and PF. The values can be reset as indicated in sect. 4.2.2.3



	I	PF	[Max Dem]
I	0.023	A	
PF	0.555		
Vrms 3F: 445.4			

Peak loads and PF, i.e. the highest average currents – calculation is made on the basis of the integration time. Values can be reset as indicated in sect. 4.2.2.2



### 5.4.2 - P Q S PF Menu

P	Q	S	PF
4.553 W	-7.874 var	9.095 VA	0.501 Cap
Vrms 3F: 439.2			

Powers and PF



Avg. W	var	VA	PF
7.354 W	-11.70 var	13.83 VA	0.532 Cap
Vrms 3F: 443.2			

Average values for powers and PF – calculation is made on the basis of the integration time. Values can be reset as indicated in sect. 4.2.2



Min. W	var	VA	PF
0.000 W	-35.87 var	0.000 VA	0.000 Cap
Vrms 3F: 446.0			

Minimum instant values for powers and PF. The values can be reset as indicated in sect. 4.2.2.3



Max. W	var	VA	PF
22.29 W	22.30 var	41.59 VA	3.349 Cap
Vrms 3F: 438.9			

Maximum instant values for powers and PF. The values can be reset as indicated in sect. 4.2.2.3



Max.O. W	var	VA	PF
16.98 W	-27.73 var	31.80 VA	0.555 Cap
Vrms 3F: 443.5			

Peak loads and PF, i.e. the highest average powers – calculation is made on the basis of the integration time. Values can be reset as indicated in sect. 4.2.2.2



### 5.4.3 - Counters Menu

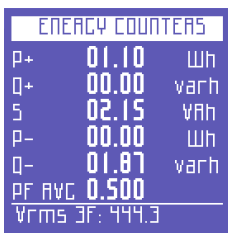

Counters of the energies absorbed (P+ Q+) and generated (P- Q-), as well as average value of the PF calculated as a kWh/kVAh ratio



### 5.4.4 - THD Menu

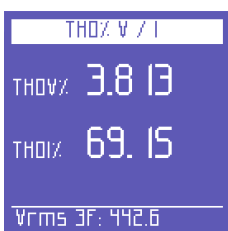

Voltage and current THD% value (Total Harmonics Distortion).



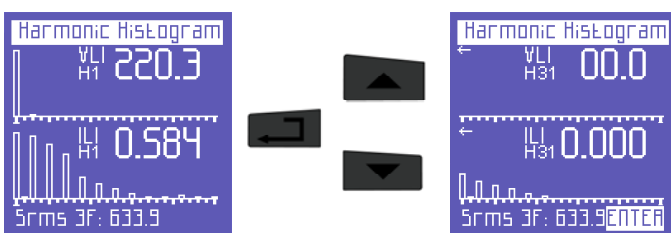

### 5.4.5 - Harmonics Menu



Display page of V and I harmonic histogram.

By pressing  , you can also access the function for selecting and scrolling the harmonics.

By pressing  and  , it is possible to select each harmonic of the histogram and check the relevant values.

The selected harmonic is marked by:

- an order number (H1, H2.....H31);
- a cursor below the histogram.

When you get past the 25<sup>th</sup> harmonic, which is the last one that can be seen on the screen, the page will change, showing the first harmonics of the spectrum on the left and the harmonics from 26<sup>th</sup> to 31<sup>st</sup> on the right.

- An arrow pointing to the left indicates that the screen virtually continues in that direction.



### 5.4.6 - Waveform Menu

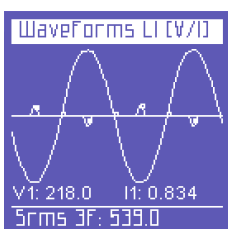

Waveform display of V and I. **NOTE:** current can be distinguished from voltage since its waveform is identified by a small square marker. The waveform width is only indicative and is automatically adjusted to the screen size.

**5.4.7 - Tariff Band Menu** (only for TOP model with Complete menu)

This menu is identical to that of the three- and two-phase connections (sect. 5.1.8)

**5.4.8 - Trend Menu** (only for TOP model with Complete menu)

This menu is identical to that of the three- and two-phase connections (sect. 5.1.9)

**5.4.9 - EN 50160 Menu** (only for TOP model with Complete menu)

Test 50160		
Test Freq:	Pass	
Test V:	Pass	
Test ThdV:	Fail	
Int.	Dips.	Swells
57	31	283

Except for the 50160 test page, where the unbalance is not analysed, this menu is identical to that of the three- and two-phase connections (sect. 5.1.10)

**5.4.10 - Alarm Log Menu** (only for TOP model with Complete menu)

This menu is identical to that of the three- and two-phase connections (sect. 5.1.11)

## 6 - MAINTENANCE

Polar Star requires no special maintenance operations. It is sufficient to observe the standard rules that apply to any electronic equipment:

- clean the instrument with a soft and not frayed cloth;
- do not use detergents, corrosive or abrasive substances;
- do not store the instrument in wet places or at temperatures which are not allowed

### 6.1 - Accuracy Checking

The manufacturer cannot determine beforehand the accuracy checking intervals, since the instrument performances depend on the way the user operates the device (type of use, environmental conditions, etc.)

We therefore suggest a periodical check of the performances by means of a sample instrument, the class of which should be higher than that of Polar Star, by fixing a yearly frequency and then increasing or decreasing the frequency of these checks on the basis of the results obtained.

If a new calibration is required, the instrument can be sent to the manufacturer's internal laboratory.

If necessary, the user can delegate the manufacturer to perform the accuracy checking.

**NOTE:** there are no authorised calibration centres except for the internal calibration laboratory of Elcontrol Energy Net.

### 6.2 - Repair

Polar Star is a sophisticated electronic product fully developed by Elcontrol Energy Net.

Any attempt to repair the instrument without the necessary skills may lead to safety risks.

We therefore recommend the user or non-authorised laboratories not to perform any repair, maintenance or calibration operations on this device. Any tampering with the device carried out by third parties will render the warranty null and void.

### 6.3 - Trouble Tracing

- The instrument does not turn on.

Make sure the supply voltage falls within the instrument specifications (sect. 3.1.1).

Make sure the external fuses are intact (sect. 3.1.1)

- The instrument does not measure correctly.

Make sure the amperometric and voltage ratios are suitable to the CTs and VTs connected to the plant (sect. 4.2.1)

Make sure the CTs are not wrongly connected (sect. 5.1).

Make sure the phase sequence is correct (sect. 5.1).

- The display is unclear.

Check the brightness and contrast levels of the LCD (sect. 4.2.5.2).

- After a few seconds, the display loses its brightness.

Check the screensaving setting (sect. 4.2.5.1)

- The display is always on, even if the setting chosen should prevent this from happening.

Check the presence of a video alarm (sect. 4.2.11)

- Some pages or menus are not displayed.

Make sure the menu setting is on Complete and not on Partial (sect. 4.2.5.3).

Make sure the connection type is correct (sect. 4.2.1.1).

- The instrument lost date and time.

Polar Star is not equipped with an internal battery. If the device is not used for a long time (more than 10 hours when it is completely charged), you need to set the clock again.

- Countless alarms have been signalled.

Make sure the alarm level has a suitable hysteresis (sect. 4.2.11.1).

## 7 - SOFTWARE POLARLINK (only for TOP model with active 485 option)

The software Polarlink is a practical remote simulator of Polar Star and allows users to connect to an instrument and totally control the relevant user interface from a remote position.

In order to use it, copy the files from the CD supplied on a PC folder. Make sure the PC is connected to the communication interface (UBS/485 or RS232/485). Then, launch the SW, which will automatically try to connect to Polar Star via all the PC serial ports.

Should the connection fail, right-click on an internal area of the SW screen to access the configuration menu.

Check/set the right connection address of Polar Star and the relevant connection speed.

Perform another "Start".

When connection to Polar Star has been established, you can operate on the SW interface with the mouse, as if you were in front of the instrument – in order to press two keys simultaneously, hold the key "Ctrl" pressed.

If "DEMO MODE" is set, the initial pages of each menu will be displayed in sequence.

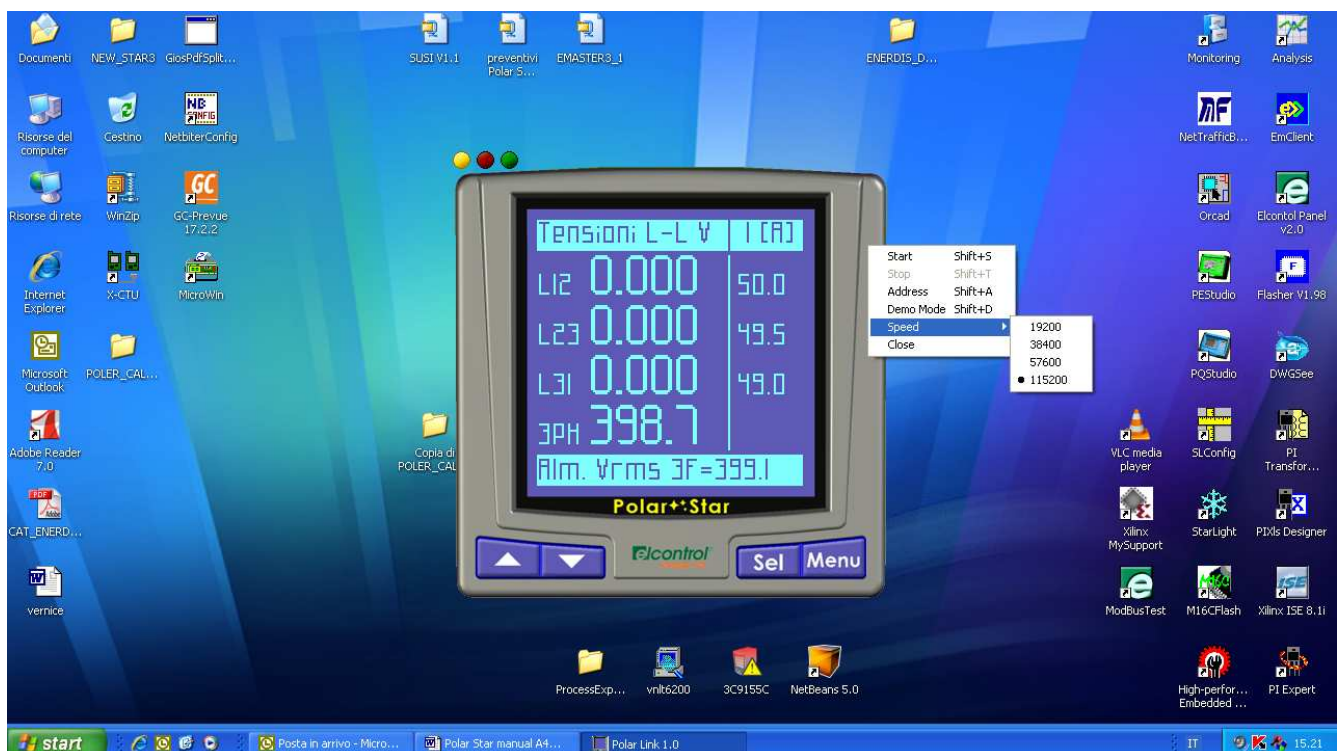

**8 - TECHNICAL SPECIFICATIONS****ENCLOSURE:**

Sizes	96x96x58 mm 96x96x96 mm (with option modules)
Overall dimensions inside the board	96x105x40 mm 96x105x77 mm (with option modules)
Material	ABS with V0 self-extinguish rating
Protection rating	IP65 (at the front), IP30 (at the back)
Weight	320 g + 35 g for each option

**DISPLAY:**

Type	LCD dot matrix (graphic type) 128x128 FSTN negative
Backlight	White LED
Languages	English, Spanish, Italian, German, French

**KEYPAD:**

Type	4 keys
Material	Silicone

**CONNECTIONS:**

Supply and voltages	Removable terminals with retaining screws
Currents	Removable terminals with retaining screws

**POWER SUPPLY:**

AC	90-230V $\pm 10\%$ 50-60Hz 8VA
DC	90-300V $\pm 10\%$ 8W
DC (with dedicated option)	12-24V $\pm 10\%$
DC (with dedicated option)	48-60V $\pm 10\%$
Consumption	5VA
Wire section	2.5mm <sup>2</sup>

**MEASURES:**

	<b>BASE Model</b>	<b>TOP Model</b>
Refresh interval of video data	1 sec.	1 sec.
Type of possible connection	Three-phase (with 3 or 4 leads), two-phase (with 2 leads) and single-phase network	Three-phase (with 3 or 4 leads), two-phase (with 2 leads) and single-phase network
Type of network that can be connected	Low and Mean Voltage (LV)	Low and Mean Voltage (LV and MV)
<b>VOLTAGE (TRMS)</b>		
Channels	3 channels with common neutral	3 channels with common neutral
Input impedance	4 Mohm	4 Mohm
Direct measure	Phase-phase: 17-700VAC 40-70Hz Phase-neutral: 10-400VAC 40-70Hz	Phase-phase: 17-700VAC 40-70Hz Phase-neutral: 10-400VAC 40-70Hz
Measure through VT	Ratio: 1-60000 Max. value displayed: 20 MV	Ratio: 1-60000 Max. value displayed: 20 MV
Permanent overload	800VAC	800VAC
Sensitivity	10V Phase-neutral, 17 Phase-phase	10V Phase-neutral, 17 Phase-phase
Wire section	2.5mm <sup>2</sup>	2.5mm <sup>2</sup>
<b>CURRENT (TRMS)</b>		
Channels	4 independent channels with shunt	4 indep. channels with internal 5A CTs
Input consumption	<1VA	<0.5VA
Scales	2	3
Direct measure	N/A	5A
Maximum measurable current	8A	8A
Measure through CT	Ratio: 1-60000 Max. value displayed: 500KA	Ratio: 1-60000 Max. value displayed: 500KA
Permanent overload	10A	10A
Intermittent overload	50A 1 sec	50A 1 sec
Sensitivity	10mA	10mA
Wire section	2.5mm <sup>2</sup>	2.5mm <sup>2</sup>
<b>POWERS</b>		
Single phase power	Values < 999 GW,Gvar,GVA	Values < 999 GW,Gvar,GVA
Total powers	Values < 999 GW,Gvar,GVA	Values < 999 GW,Gvar,GVA
<b>ENERGY COUNTERS</b>		
Max. value before reset	99999999 kWh,kvarh,kVAh	99999999 kWh,kvarh,kVAh

<b>ACCURACY</b>		
Voltages	$\pm 0.25\% + 0.05\%FS$	$\pm 0.25\% + 0.05\%FS$
Currents	$\pm 0.25\% + 0.05\%FS$	$\pm 0.25\% + 0.05\%FS$
Powers	$\pm 0.5\% + 0.05\%FS$	$\pm 0.5\% + 0.05\%FS$
Power Factor (PF)	$\pm 0.5^\circ$	$\pm 0.5^\circ$
Frequency	$\pm 0.01$ Hz (40-70Hz)	$\pm 0.01$ Hz (40-70Hz)
Active energy count (kW)	Class 0.5	Class 0.5
Reactive energy count (kVar)	Class 1	Class 1
<b>EN50160 parameter ANALYSIS</b>		
Blackouts		>500mS
Voltage losses		>500mS
Overvoltages		>500mS

**CONDITIONS OF USE:**

Operating temperature	from -10 to +55 °C
Storage temperature	from -20 to +85 °C
Relative humidity	Max 95%
Maximum operation altitude (a.s.l.)	2,000 m

**EC COMPLIANCE:**

Directives	93/68/EEC (LV electrical equipment); 89/336/EEC and 2004/108/EC (EMC - Electromagnetic Compatibility) 2006/95/EC - 72/23/EEC (LVD - Low Voltage Directive); 2002/95/EC (RoHS - Restriction of Hazardous Substances); 2002/96/EC and 2003/108/EC (WEEE: Waste Electrical and Electronic Equipment)
------------	---

**REFERENCE STANDARDS:**

Safety	EN 61010-1
Electromagnetic Compatibility (EMC)	EN 61326 EN 61326/A1 EN 61326/A2 EN 61326/A3
Mechanical dimensions	IEC 61554 (ex DIN 43700)
Temperature	IEC 60068-2-1 (operating temperature) IEC 60068-2-2 (storage temperature)
Vibrations	IEC 60068-2-6
Humidity	IEC 60068-2-30 (humidity)
Overload	IEC 60947-1

## 9 - OPTION MODULES

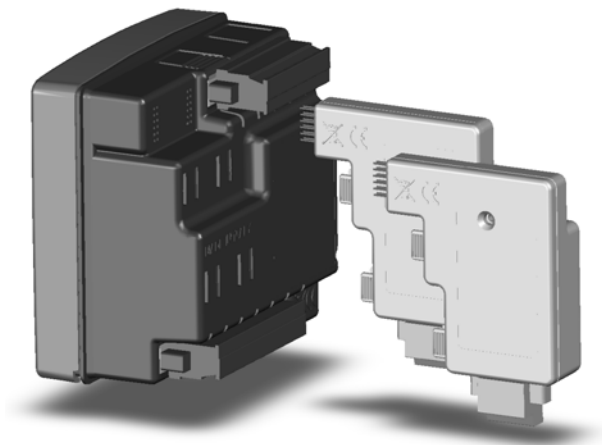

Polar Star functions can be expanded through optional modules which can be inserted at the back of the instrument.

You can insert a maximum of two different options for each instrument.

Options should be inserted when the instrument is switched off. Pay attention not to damage the pins of the plug-in connector.

After inserting the option, turn on the instrument. All the pages relating to the set-up and display of the functions enabled will be automatically unlocked.

### 9.1 - RS485 Option Modules

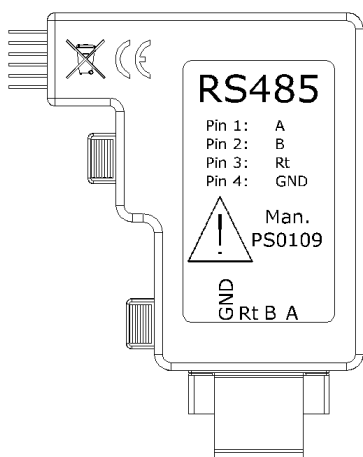

This option allows you to connect Polar Star to an RS485 network to remotely transmit a long set of information via the MODBUS, BCD or IEEE protocols.

In order to guarantee the interchangeability between Polar Star and the previous instruments produced by Elcontrol, the addresses of most standard MODBUS registers have not been modified. Furthermore, a new set of registers which start from the address 1000 has been especially dedicated to the new information that this instrument places at the user's disposal.

Moreover, in order to facilitate the correct network installation of the instrument, a special sub-menu has been created to indicate the traffic (for the instrument in question) and any possible communication errors.



#### 9.1.1 - RS485 Option Connections

A label placed on the side of the RS485 option of Polar Star helps you identify the different connections.

- Pin 1 A
- Pin 2 B
- Pin 3 (make a shunt between pin 2 and 3 to connect the line termination 110 Ohm internal resistance)
- Pin 4 GND

#### 9.1.2 - RS485 Option Set-up

The 485 set-up menu only displays when the relevant option is connected and allows you to set the following parameters:

- data transfer speed (Baud rate) between the following: 4800, 9600, 19200, 38400, 57600, 115200 bps;
- parity type: none, even, odd;
- protocol type: BCD, IEEE;
- instrument address (which must be unique in the instrument network)
- possibility to access the communication test page pushing 
- possibility to access the date/time synchronization page of the network instruments pushing 

### 9.1.3 – Communication Test

This page is helpful during the instrument installation in an RS485 network or during a subsequent check of the instrument operation.

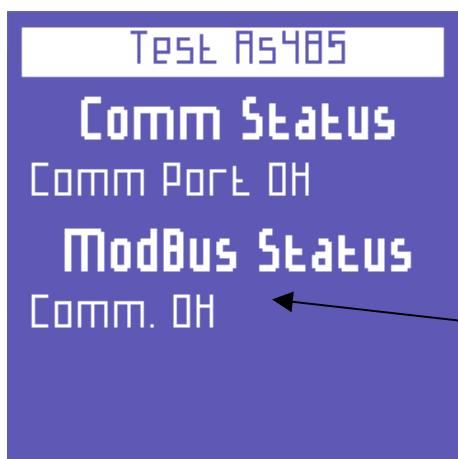

- In this position, the working condition (No Traffic, Comm. OK) or the type of error (Checksum error, framing error etc.) which occur during the instrument communication are displayed.

NB. If the error does not disappear, make sure the configuration parameters (see section 9.1.2) and the polarity of A and B signals connected to the RS485 option are correct.

Press the key  to go back to the serial configuration menu

### 9.1.4 – Date/Time Synchronization (Synchronization is only possible from address 1)

In the date/time synchronization set-up menu (which can only be accessed if the instrument address is the No. 1), it is possible to set the following parameters:

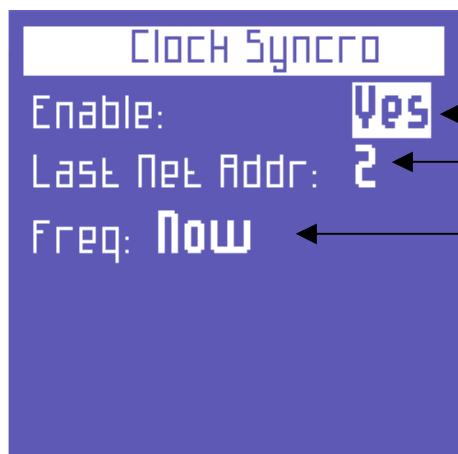

- Enabling date/time synchronization
- Entering the last network instrument address to synchronize
- Deciding whether to perform the synchronization immediately or at the end of each day

NB. Prevent repetitive synchronization from being performed every day if the instruments connected to the RS485 line can be interrogated by a management SW. In this case, message conflicts may arise on the line

### 9.1.5 - MODBUS Measurement Registers

Standard Elcontrol MODBUS registers:

0001	V (3ph)	Three-phase voltage (mantissa in BCD)
0002	V (3 ph)	Three-phase voltage (exponent in binary format)
0003	A (3 ph)	Three-phase current
0004	A (3 ph)	Three-phase current
0005	kW (3 ph)	Three-phase active power
0006	kW (3 ph)	Three-phase active power
0007	kVA (3 ph)	Three-phase reactive power
0008	kVA (3 ph)	Three-phase reactive power
0009	kVA (3 ph)	Three-phase apparent power
0010	kVA (3 ph)	Three-phase apparent power
0011	PF (3 ph)	Three-phase power factor
0012	PF (3 ph)	Three-phase power factor

0013	kW avg (3 ph)	Average active power (average is calculated on the basis of the integration time set, see 4.2.2)
0014	kW avg (3 ph)	Average active power
0015	kVA avg (3 ph)	Average apparent power
0016	kVA avg (3 ph)	Average apparent power
0017	kW max (3 ph)	Peak active power (maximum demand value of the average active powers)
0018	kW max (3 ph)	Peak active power
0019	kVA max (3 ph)	Peak apparent power (maximum demand value of the average apparent powers)
0020	kVA max (3 ph)	Peak apparent power
0021	kWh (3 ph)	Three-phase counter of active energy (integer part in BCD)
0022	kWh (3 ph)	Three-phase counter of active energy (integer part in BCD)
0023	kWh (3 ph)	Three-phase counter of active energy (decimal part in BCD)
0024	kVArh (3 ph)	Three-phase counter of reactive energy
0025	kVArh (3 ph)	Three-phase counter of reactive energy
0026	kVArh (3 ph)	Three-phase counter of reactive energy
0027	S/N	Serial number
0028	S/N	Serial number
0029	V (L1)	Voltage L1
0030	V (L1)	Voltage L1
0031	V (L2)	Voltage L2
0032	V (L2)	Voltage L2
0033	V (L3)	Voltage L3
0034	V (L3)	Voltage L3
0035	A (L1)	Current L1
0036	A (L1)	Current L1
0037	A (L2)	Current L2
0038	A (L2)	Current L2
0039	A (L3)	Current L3
0040	A (L3)	Current L3
0041	kW (L1)	Active power L1
0042	kW (L1)	Active power L1
0043	kW (L2)	Active power L2
0044	kW (L2)	Active power L2
0045	kW (L3)	Active power L3
0046	kW (L3)	Active power L3
0047	Hz	Frequency (measured on L1)
0048	Hz	Frequency (measured on L1)
0049	kVAr (L1)	Reactive power L1 measured (used by the instrument for internal calculations)
0050	kVAr (L1)	Reactive power L1 measured
0051	kVAr (L2)	Reactive power L2 measured
0052	kVAr (L2)	Reactive power L2 measured
0053	kVAr (L3)	Reactive power L3 measured
0054	kVAr (L3)	Reactive power L3 measured
0055	kVA (L1)	Apparent power L1
0056	kVA (L1)	Apparent power L1
0057	kVA (L2)	Apparent power L2
0058	kVA (L2)	Apparent power L2
0059	kVA (L3)	Apparent power L3
0060	kVA (L3)	Apparent power L3
0061	kVAr (L1)	Reactive power L1 calculated (value shown on the instrument display)
0062	kVAr (L1)	Reactive power L1 calculated
0063	kVAr (L2)	Reactive power L2 calculated
0064	kVAr (L2)	Reactive power L2 calculated
0065	kVAr (L3)	Reactive power L3 calculated
0066	kVAr (L3)	Reactive power L3 calculated
0067	pf (L1)	Power factor L1
0068	pf (L1)	Power factor L1
0069	pf (L2)	Power factor L2
0070	pf (L2)	Power factor L2
0071	pf (L3)	Power factor L3
0072	pf (L3)	Power factor L3
0073	A n	Neutral current
0074	A n	Neutral current
0075	A avg (L1)	Average current L1 (average is calculated on the basis of the integration time set, see 4.2.2)
0076	A avg (L1)	Average current L1
0077	A avg (L2)	Average current L2
0078	A avg (L2)	Average current L2
0079	A avg (L3)	Average current L3
0080	A avg (L3)	Average current L3
0081	Amax (L1)	Peak current L1 (maximum demand value of the average currents)
0082	Amax (L1)	Peak current L1
0083	Amax (L2)	Peak current L2
0084	Amax (L2)	Peak current L2
0085	Amax (L3)	Peak current L3
0086	Amax (L3)	Peak current L3

0087	kVAr avg	Average reactive power
0088	kVAr avg	Average reactive power
0089	kVAr max	Peak reactive power (maximum demand value of the average reactive powers)
0090	kVAr max	Peak reactive power
0091	kWh cog	Three-phase counter of generated active energy
0092	kWh cog	Three-phase counter of generated active energy
0093	kWh cog	Three-phase counter of generated active energy
0094	kVArh cog	Three-phase counter of generated reactive energy (lagging)
0095	kVArh cog	Three-phase counter of generated reactive energy
0096	kVArh cog	Three-phase counter of generated reactive energy
0097	kVAh	Three-phase counter of apparent energy
0098	kVAh	Three-phase counter of apparent energy
0099	kVAh	Three-phase counter of apparent energy
0100	kWh T1	Three-phase counter of active energy tariff T1 (*)
0101	kWh T1	Three-phase counter of active energy tariff T1 (*)
0102	kWh T1	Three-phase counter of active energy tariff T1 (*)
0103	kWh T2	Three-phase counter of active energy tariff T2 (*)
0104	kWh T2	Three-phase counter of active energy tariff T2 (*)
0105	kWh T2	Three-phase counter of active energy tariff T2 (*)
0106	kWh T3	Three-phase counter of active energy tariff T3 (*)
0107	kWh T3	Three-phase counter of active energy tariff T3 (*)
0108	kWh T3	Three-phase counter of active energy tariff T3 (*)
0109	kWh T4	Three-phase counter of active energy tariff T4 (*)
0110	kWh T4	Three-phase counter of active energy tariff T4 (*)
0111	kWh T4	Three-phase counter of active energy tariff T4 (*)
0112	Inp1	Digital input counter 1
0113	Inp1	Digital input counter 1
0114	Inp1	Digital input counter 1
0115	Inp2	Digital input counter 2
0116	Inp2	Digital input counter 2
0117	Inp2	Digital input counter 2
0197	THD Vtot%	Total harmonic distortion Vtot
0198	THD Vtot %	Total harmonic distortion Vtot
0199	THD Itot%	Total harmonic distortion Itot
0200	THD Itot%	Total harmonic distortion Itot
0201	THD V1%	Total harmonic distortion V1
0202	THD V1%	Total harmonic distortion V1
0203	THD V2%	Total harmonic distortion V2
0204	THD V2%	Total harmonic distortion V2
0205	THD V3%	Total harmonic distortion V3
0206	THD V3%	Total harmonic distortion V3
0207	THD A1%	Total harmonic distortion A1
0208	THD A1%	Total harmonic distortion A1
0209	THD A2%	Total harmonic distortion A2
0210	THD A2%	Total harmonic distortion A2
0211	THD A3%	Total harmonic distortion A3
0212	THD A3%	Total harmonic distortion A3

### Harmonic Voltage Data

#### H01 (Fundamental)

0213	V1 h01	Voltage L1 harmonic 1
0214	V1 h01	Voltage L1 harmonic 1
0215	V2 h01	Voltage L2 harmonic 1
0216	V2 h01	Voltage L2 harmonic 1
0217	V3 h01	Voltage L3 harmonic 1
0218	V3 h01	Voltage L3 harmonic 1

#### H02 harmonic 2

0219	V1 h02	Voltage L1 harmonic 2
0220	V1 h02	Voltage L1 harmonic 2
0221	V2 h02	Voltage L2 harmonic 2
0222	V2 h02	Voltage L2 harmonic 2
0223	V3 h02	Voltage L3 harmonic 2
0224	V3 h02	Voltage L3 harmonic 2

.....

Consecutive addresses up to the 25<sup>th</sup> harmonic:

#### H25 harmonic 25

0357	V1 h25	Voltage L1 harmonic 25
0358	V1 h25	Voltage L1 harmonic 25
0359	V2 h25	Voltage L2 harmonic 25
0360	V2 h25	Voltage L2 harmonic 25
0361	V3 h25	Voltage L3 harmonic 25
0362	V3 h25	Voltage L3 harmonic 25

**Harmonic Current Data**

## H01 (Fundamental)

0375	A1 h01	Current L1 harmonic 1
0376	A1 h01	Current L1 harmonic 1
0377	A2 h01	Current L2 harmonic 1
0378	A2 h01	Current L2 harmonic 1
0379	A3 h01	Current L3 harmonic 1
0380	A3 h01	Current L3 harmonic 1

## H02 Harmonic 2

0381	A1 h02	Current L1 harmonic 2
0382	A1 h02	Current L1 harmonic 2
0383	A2 h02	Current L2 harmonic 2
0384	A2 h02	Current L2 harmonic 2
0385	A3 h02	Current L3 harmonic 2
0386	A3 h02	Current L3 harmonic 2

.....

.....

Consecutive addresses up to the 25<sup>th</sup> harmonic:

## H25 Harmonic 25

0519	A1 h025	Current L1 harmonic 25
0520	A1 h025	Current L1 harmonic 25
0521	A2 h025	Current L2 harmonic 25
0522	A2 h025	Current L2 harmonic 25
0523	A3 h025	Current L3 harmonic 25
0524	A3 h025	Current L3 harmonic 25

## Phase Angle Harmonic Current Data (cosphi)

## H01 (Fundamental)

537	Pf1 h01	Phase power factor L1 harmonic 1
538	Pf1 h01	Phase power factor L1 harmonic 1
539	Pf2 h01	Phase power factor L2 harmonic 1
540	Pf2 h01	Phase power factor L2 harmonic 1
541	Pf3 h01	Phase power factor L3 harmonic 1
542	Pf3 h01	Phase power factor L3 harmonic 1

## H02 Harmonic 2

543	Pf1 h02	Phase power factor L1 harmonic 2
544	Pf1 h02	Phase power factor L1 harmonic 2
545	Pf2 h02	Phase power factor L2 harmonic 2
546	Pf2 h02	Phase power factor L2 harmonic 2
547	Pf3 h02	Phase power factor L3 harmonic 2
548	Pf3 h02	Phase power factor L3 harmonic 2

.....

.....

Consecutive addresses up to the 25<sup>th</sup> harmonic:

## H31 Harmonic 25

681	Pf1 h31	Phase power factor L1 harmonic 31
682	Pf1 h31	Phase power factor L1 harmonic 31
683	Pf2 h31	Phase power factor L2 harmonic 31
684	Pf2 h31	Phase power factor L2 harmonic 31
685	Pf3 h31	Phase power factor L3 harmonic 31
686	Pf3 h31	Phase power factor L3 harmonic 31

(\*) The registers marked with an asterisk are not available in POLAR STAR BASE

**NEW POLAR STAR REGISTERS**

1001	V (3ph)	Three-phase voltage (mantissa in BCD)
1002	V (3 ph)	Three-phase voltage (exponent in binary format)
1003	A (3 ph)	Three-phase current
1004	A (3 ph)	Three-phase current
1005	kW (3 ph)	Three-phase active power
1006	kW (3 ph)	Three-phase active power
1007	kVAr (3 ph)	Three-phase reactive power
1008	kVAr (3 ph)	Three-phase reactive power
1009	kVA (3 ph)	Three-phase apparent power
1010	kVA (3 ph)	Three-phase apparent power
1011	PF (3 ph)	Three-phase power factor
1012	PF (3 ph)	Three-phase power factor

1013	V (L1)	Voltage L1
1014	V (L1)	Voltage L1
1015	V (L2)	Voltage L2
1016	V (L2)	Voltage L2
1017	V (L3)	Voltage L3
1018	V (L3)	Voltage L3
1019	V (L1)	Voltage L1-L2
1020	V (L1)	Voltage L1-L2
1021	V (L2)	Voltage L2-L3
1022	V (L2)	Voltage L2-L3
1023	V (L3)	Voltage L3-L1
1024	V (L3)	Voltage L3-L1
1025	A (L1)	Current L1
1026	A (L1)	Current L1
1027	A (L2)	Current L2
1028	A (L2)	Current L2
1029	A (L3)	Current L3
1030	A (L3)	Current L3
1031	A n	Neutral current
1032	A n	Neutral current
1033	kW (L1)	Active power L1
1034	kW (L1)	Active power L1
1035	kW (L2)	Active power L2
1036	kW (L2)	Active power L2
1037	kW (L3)	Active power L3
1038	kW (L3)	Active power L3
1039	kVAr (L1)	Reactive power L1 calculated
1040	kVAr (L1)	Reactive power L1 calculated
1041	kVAr (L2)	Reactive power L2 calculated
1042	kVAr (L2)	Reactive power L2 calculated
1043	kVAr (L3)	Reactive power L3 calculated
1044	kVAr (L3)	Reactive power L3 calculated
1045	kVA (L1)	Apparent power L1
1046	kVA (L1)	Apparent power L1
1047	kVA (L2)	Apparent power L2
1048	kVA (L2)	Apparent power L2
1049	kVA (L3)	Apparent power L3
1050	kVA (L3)	Apparent power L3
1051	pf (L1)	Power factor L1
1052	pf (L1)	Power factor L1
1053	pf (L2)	Power factor L2
1054	pf (L2)	Power factor L2
1055	pf (L3)	Power factor L3
1056	pf (L3)	Power factor L3
1057	Hz	Frequency (measured on L1)
1058	Hz	Frequency (measured on L1)
1059	Unbalance	Unbalance of three-phase voltages
1060	Unbalance	Unbalance of three-phase voltages
1061	V avg (L1)	Average voltage L1
1062	V avg (L1)	Average voltage L1
1063	V avg (L2)	Average voltage L2
1064	V avg (L2)	Average voltage L2
1065	V avg (L3)	Average voltage L3
1066	V avg (L3)	Average voltage L3
1067	V min (L1)	Minimum voltage L1
1068	V min (L1)	Minimum voltage L1
1069	V min (L2)	Minimum voltage L2
1070	V min (L2)	Minimum voltage L2
1071	V min (L3)	Minimum voltage L3
1072	V min (L3)	Minimum voltage L3
1073	V max (L1)	Maximum voltage L1
1074	V max (L1)	Maximum voltage L1
1075	V max (L2)	Maximum voltage L2
1076	V max (L2)	Maximum voltage L2
1077	V max (L3)	Maximum voltage L3
1078	V max (L3)	Maximum voltage L3
1079	A avg (L1)	Average current L1
1080	A avg (L1)	Average current L1
1081	A avg (L2)	Average current L2
1082	A avg (L2)	Average current L2
1083	A avg (L3)	Average current L3
1084	A avg (L3)	Average current L3
1085	A min (L1)	Minimum current L1
1086	A min (L1)	Minimum current L1

1087	A min (L2)	Minimum current L2
1088	A min (L2)	Minimum current L2
1089	A min (L3)	Minimum current L3
1090	A min (L3)	Minimum current L3
1091	A max (L1)	Maximum current L1
1092	A max (L1)	Maximum current L1
1093	A max (L2)	Maximum current L2
1094	A max (L2)	Maximum current L2
1095	A max (L3)	Maximum current L3
1096	A max (L3)	Maximum current L3
1097	Amax (L1)	Peak current L1 (Maximum demand)
1098	Amax (L1)	Peak current L1 (Maximum demand)
1099	Amax (L2)	Peak current L2 (Maximum demand)
1100	Amax (L2)	Peak current L2 (Maximum demand)
1101	Amax (L3)	Peak current L3 (Maximum demand)
1102	Amax (L3)	Peak current L3 (Maximum demand)
1103	kW avg (3 ph )	Average active power
1104	kW avg (3 ph )	Average active power
1105	kW min (3 ph )	Minimum active power
1106	kW min (3 ph )	Minimum active power
1107	kW max (3 ph )	Maximum active power
1108	kW max (3 ph )	Maximum active power
1109	kW max (3 ph )	Peak active power (Maximum demand)
1110	kW max (3 ph )	Peak active power (Maximum demand)
1111	kVAr avg (3 ph)	Average reactive power
1112	kVAr avg (3 ph)	Average reactive power
1113	kVar min (3 ph )	Minimum reactive power
1114	kVar min (3 ph )	Minimum reactive power
1115	kVar max (3 ph )	Maximum reactive power
1116	kVar max (3 ph )	Maximum reactive power
1117	kVAr max (3 ph )	Peak reactive power (Maximum demand)
1118	kVAr max (3 ph )	Peak reactive power (Maximum demand)
1119	kVA avg (3 ph )	Average apparent power
1120	kVA avg (3 ph )	Average apparent power
1121	kVA min (3 ph )	Minimum apparent power
1122	kVA min (3 ph )	Minimum apparent power
1123	kVA max (3 ph )	Maximum apparent power
1124	kVA max (3 ph )	Maximum apparent power
1125	kVA max (3 ph )	Peak apparent power (Maximum demand)
1126	kVA max (3 ph )	Peak apparent power (Maximum demand)
1127	PF avg (3 ph )	Average power factor
1128	PF avg (3 ph )	Average power factor
1129	PF min (3 ph )	Minimum power factor
1130	PF min (3 ph )	Minimum power factor
1131	PF max (3 ph )	Maximum power factor
1132	PF max (3 ph )	Maximum power factor
1133	PF max (3 ph )	Maximum average power factor
1134	PF max (3 ph )	Maximum average power factor
1135	kWh (3 ph )	Three-phase counter of active energy (integer part in BCD)
1136	kWh (3 ph )	Three-phase counter of active energy (integer part in BCD)
1137	kWh (3 ph )	Three-phase counter of active energy (decimal part in BCD)
1138	kVArh (3 ph )	Three-phase counter of reactive energy
1139	kVArh (3 ph )	Three-phase counter of reactive energy
1140	kVArh (3 ph )	Three-phase counter of reactive energy
1141	kVAh (3 ph )	Three-phase counter of apparent energy
1142	kVAh (3 ph )	Three-phase counter of apparent energy
1143	kVAh (3 ph )	Three-phase counter of apparent energy
1144	kWh cog (3 ph )	Three-phase counter of generated active energy
1145	kWh cog (3 ph )	Three-phase counter of generated active energy
1146	kWh cog (3 ph )	Three-phase counter of generated active energy
1147	kVArh cog	Three-phase counter of generated reactive energy (lagging)
1148	kVArh cog	Three-phase counter of generated reactive energy
1149	kVArh cog	Three-phase counter of generated reactive energy
1150	kVAh (3 ph )	Three-phase counter of apparent energy
1151	kVAh (3 ph )	Three-phase counter of apparent energy
1152	kVAh (3 ph )	Three-phase counter of apparent energy
1153	kWh (L1 )	Three-phase counter of active energy L1
1154	kWh (L1 )	Three-phase counter of active energy L1
1155	kWh (L1 )	Three-phase counter of active energy L1
1156	kWh (L2 )	Three-phase counter of active energy L2
1157	kWh (L2 )	Three-phase counter of active energy L2
1158	kWh (L2 )	Three-phase counter of active energy L2
1159	kWh (L3 )	Three-phase counter of active energy L3
1160	kWh (L3 )	Three-phase counter of active energy L3
1161	kWh (L3 )	Three-phase counter of active energy L3



1237	kVarh T2	Three-phase counter of generated reactive energy tariff T2 (*)
1238	kVarh T2	Three-phase counter of generated reactive energy tariff T2 (*)
1239	kVarh T2	Three-phase counter of generated reactive energy tariff T2 (*)
1240	kVarh T3	Three-phase counter of generated reactive energy tariff T3 (*)
1241	kVarh T3	Three-phase counter of generated reactive energy tariff T3 (*)
1242	kVarh T3	Three-phase counter of generated reactive energy tariff T3 (*)
1243	kVarh T4	Three-phase counter of generated reactive energy tariff T4 (*)
1244	kVarh T4	Three-phase counter of generated reactive energy tariff T4 (*)
1245	kVarh T4	Three-phase counter of generated reactive energy tariff T4 (*)
1246	Inp1	Digital input counter 1
1247	Inp1	Digital input counter 1
1248	Inp1	Digital input counter 1
1249	Inp2	Digital input counter 2
1250	Inp2	Digital input counter 2
1251	Inp2	Digital input counter 2
1252	THD Vtot%	Total harmonic distortion Vtot
1253	THD Vtot %	Total harmonic distortion Vtot
1254	THD Itot%	Total harmonic distortion Itot
1255	THD Itot%	Total harmonic distortion Itot
1256	THD V1%	Harmonic distortion V1
1257	THD V1%	Harmonic distortion V1
1258	THD V2%	Harmonic distortion V2
1259	THD V2%	Harmonic distortion V2
1260	THD V3%	Harmonic distortion V3
1261	THD V3%	Harmonic distortion V3
1262	THD A1%	Harmonic distortion I1
1263	THD A1%	Harmonic distortion I1
1264	THD A2%	Harmonic distortion I2
1265	THD A2%	Harmonic distortion I2
1266	THD A3%	Harmonic distortion I3
1267	THD A3%	Harmonic distortion I3

### Harmonic Voltage Data

#### H01 (Fundamental)

1268	V1 h01	Voltage L1 harmonic 1
1269	V1 h01	Voltage L1 harmonic 1
1270	V2 h01	Voltage L2 harmonic 1
1271	V2 h01	Voltage L2 harmonic 1
1272	V3 h01	Voltage L3 harmonic 1
1273	V3 h01	Voltage L3 harmonic 1

#### H02 harmonic 2

1274	V1 h02	Voltage L1 harmonic 2
1275	V1 h02	Voltage L1 harmonic 2
1276	V2 h02	Voltage L2 harmonic 2
1277	V2 h02	Voltage L2 harmonic 2
1278	V3 h02	Voltage L3 harmonic 2
1279	V3 h02	Voltage L3 harmonic 2

.....

.....

Consecutive addresses up to the 31<sup>st</sup> harmonic:

#### H31 harmonic 31

1448	V1 h31	Voltage L1 harmonic 31
1449	V1 h31	Voltage L1 harmonic 31
1450	V2 h31	Voltage L2 harmonic 31
1451	V2 h31	Voltage L2 harmonic 31
1452	V3 h31	Voltage L3 harmonic 31
h1453	V3 h31	Voltage L3 harmonic 31

### Harmonic Current Data

#### H01 (Fundamental)

1460	A1 h01	Current L1 harmonic 1
1461	A1 h01	Current L1 harmonic 1
1462	A2 h01	Current L2 harmonic 1
1463	A2 h01	Current L2 harmonic 1
1464	A3 h01	Current L3 harmonic 1
1465	A3 h01	Current L3 harmonic 1

H02 Harmonic 2		
1466	A1 h02	Current L1 harmonic 1
1467	A1 h02	Current L1 harmonic 1
1468	A2 h02	Current L2 harmonic 1
1469	A2 h02	Current L2 harmonic 1
1470	A3 h02	Current L3 harmonic 1
1471	A3 h02	Current L3 harmonic 1

.....

.....

Consecutive addresses up to the 31<sup>st</sup> harmonic:

H31 Harmonic 31		
1640	A1 h31	Current L1 harmonic 31
1641	A1 h31	Current L1 harmonic 31
1642	A2 h31	Current L2 harmonic 31
1643	A2 h31	Current L2 harmonic 31
1644	A3 h31	Current L3 harmonic 31
1645	A3 h31	Current L3 harmonic 31

Phase Angle Harmonic Current Data (cosphi)

H01 (Fundamental)		
1652	Pf1 h01	Phase power factor L1 harmonic 1
1653	Pf1 h01	Phase power factor L1 harmonic 1
1654	Pf2 h01	Phase power factor L2 harmonic 1
1655	Pf2 h01	Phase power factor L2 harmonic 1
1656	Pf3 h01	Phase power factor L3 harmonic 1
1657	Pf3 h01	Phase power factor L3 harmonic 1

H02 Harmonic 2		
1658	Pf1 h02	Phase power factor L1 harmonic 2
1659	Pf1 h02	Phase power factor L1 harmonic 2
1660	Pf2 h02	Phase power factor L2 harmonic 2
1661	Pf2 h02	Phase power factor L2 harmonic 2
1662	Pf3 h02	Phase power factor L3 harmonic 2
1663	Pf3 h02	Phase power factor L3 harmonic 2

.....

.....

Consecutive addresses up to the 31<sup>st</sup> harmonic:

H31 Harmonic 31		
1832	Pf1 h31	Phase power factor L1 harmonic 31
1833	Pf1 h31	Phase power factor L1 harmonic 31
1834	Pf2 h31	Phase power factor L2 harmonic 31
1835	Pf2 h31	Phase power factor L2 harmonic 31
1836	Pf3 h31	Phase power factor L3 harmonic 31
1837	Pf3 h31	Phase power factor L3 harmonic 31

1844	Test Pass/Fail (1,0)	Freq 50160 (*)
1845	Test Pass/Fail (1,0)	Freq 50160 (*)
1846	Test Pass/Fail (1,0)	V1 50160 (*)
1847	Test Pass/Fail (1,0)	V1 50160 (*)
1848	Test Pass/Fail (1,0)	V2 50160 (*)
1849	Test Pass/Fail (1,0)	V2 50160 (*)
1850	Test Pass/Fail (1,0)	V3 50160 (*)
1851	Test Pass/Fail (1,0)	V3 50160 (*)
1852	Test Pass/Fail (1,0)	Unbal 50160 (*)
1853	Test Pass/Fail (1,0)	Unbal 50160 (*)
1854	Test Pass/Fail (1,0)	ThdV1 50160 (*)
1855	Test Pass/Fail (1,0)	ThdV1 50160 (*)
1856	Test Pass/Fail (1,0)	ThdV2 50160 (*)
1857	Test Pass/Fail (1,0)	ThdV2 50160 (*)
1858	Test Pass/Fail (1,0)	ThdV3 50160 (*)
1859	Test Pass/Fail (1,0)	ThdV3 50160 (*)

1860	Number of Blackouts - INTERRUPTIONS (*)
1861	Number of Blackouts - INTERRUPTIONS (*)
1862	Number of Voltage Losses - DIPS (*)
1863	Number of Voltage Losses - DIPS (*)
1864	Number of Overvoltages – SWELLS (*)
1865	Number of Overvoltages – SWELLS (*)

Please refer to the document on the Elcontrol site in case of use and development of Customer's SW.

(\*) The registers marked with an asterisk are not available in POLAR STAR BASE

## 9.2 - ALM Option

This option allows Polar Star to have 2 optoisolated outputs, which are equivalent to 2 normally open free contacts. These outputs can be used in three different ways:

**Pulse output:** Each output can be associated with an energy counter. The output contact will be closed, generating a number of pulses (10/100mS) which is proportionate to the counter increases (e.g. every 10Wh).

**Alarm output:** Each output can be associated with a measure which can be selected from the set-up. The output contact will be closed each time the quantity value will exceed the set lower or upper limits.

**Relay output:** This mode allows you to remotely control the two output contacts through the MODBUS "Force Single Coil" control (Coil No. 11 for out1 and No. 12 for out2)

### 9.2.1 - ALM Option Connections

Technical characteristics:

Nominal voltage: 24VDC

Maximum current: 100mA

A label placed on the side of the RS485 option of Polar Star helps you identify the different connections.

Pin 1 Out 1

Pin 2 Out 1

Pin 3 Out 2

Pin 4 Out 2

### 9.2.2 - ALM Option Set-up

In the Alarm/Pulse Set-up menu, which is only displayed when the relevant option is connected, it is possible to set the following parameters:

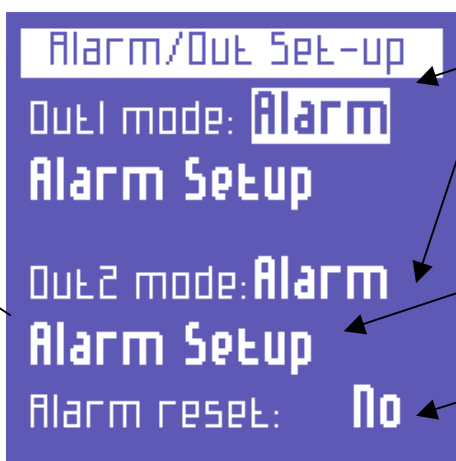

one of the three modes to use output 1 or 2:

**ALARM:** the contact output 1 or 2 is associated with an alarm condition which can be set from ALARM SET-UP

**PULSE:** the contact output 1 or 2 is associated with a measured energy value which can be set from PULSE SET-UP

**RELAY:** the contact is remotely controlled through a MODBUS control

- allows you to access the alarm or pulse set-up page of the relevant output by pushing

- allows you to reset the alarms in the ALARM LOG menu (see section 5.3.11)

### 9.2.3 - Alarm 1 or 2 Set-up

In the Alarm Set-up page it is possible to set the following parameters:

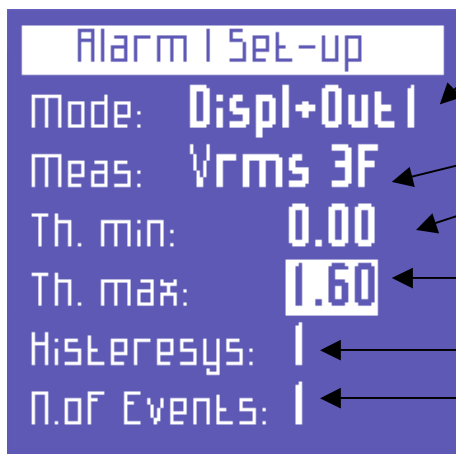

- where to direct the alarm signal: on the display, on the corresponding output or both of them simultaneously.

- the measured quantity to be controlled

- the minimum threshold

- the maximum threshold

- the hysteresis

- the number of consecutive times the quantity must be out of limits (the two thresholds) in order for the alarm condition to occur.

### 9.2.4 - Pulse Output 1 or 2 Set-up

In the Pulse Set-up page it is possible to set the following parameters:

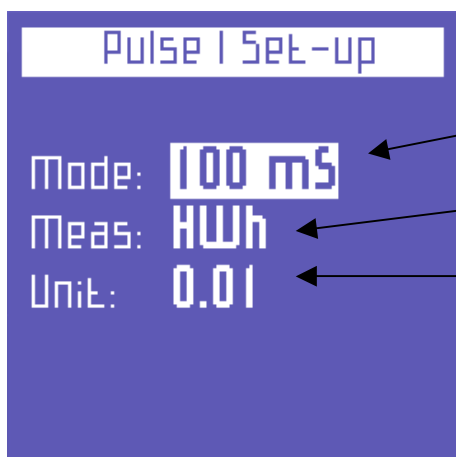

- duration of the single pulse: 10 or 100 mS
- measured energy counter that generates the pulse: kW, kVAr, kVA.
- the value associated with each single pulse

### 9.3 - Digital Inputs Option

This option allows Polar Star to have 2 optoisolated inputs, which can be connected to 2 clean external contacts. These inputs can be used in two different ways:

**Auxiliary counters:** For counting the pulses coming from external counters and display them on the "Counters" menu.

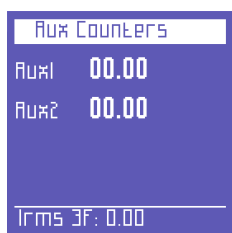

**Contacts for tariff identification:** For selecting the time period according to the closing of two normally open contacts which can be connected from the outside.

#### 9.3.1 - Digital Inputs Option Connections

Technical characteristics:

Only connect clean contacts. 18VDC supply is provided by the instrument.

A label placed on the side of the RS485 option of Polar Star helps you identify the different connections.

- Pin 1 Input 2
- Pin 2 Input 2
- Pin 3 Input 1
- Pin 4 Input 1

When in "Counter" mode:

Input 1 increases the AUX1 counter

Input 2 increases the AUX2 counter

When in "Tariff Selection" mode:

Input 1	Input 2	Selected tariff
Open	Open	T1
Close	Open	T2
Open	Close	T3
Close	Close	T4

### 9.3.2 - Digital Inputs Set-up

In the Digital Input Set-up menu, which is only displayed when the relevant option is connected, it is possible to set the following parameters:

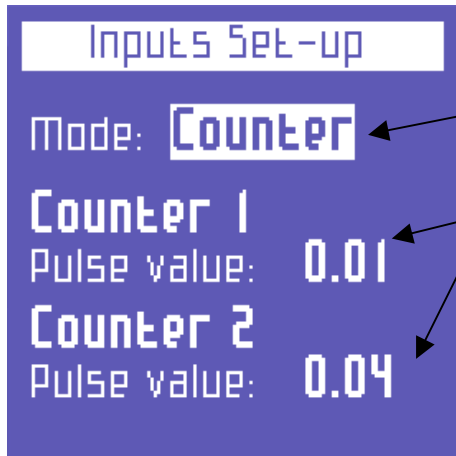

• the use of the two inputs: auxiliary counters or time period selectors

• If the auxiliary counters use has been chosen, it is possible to set the value to be associated with each single pulse