

## Other Protistor® Fuses

### BS88-4 Fuses

### 000, 2.000 BS88Z - 690 VAC

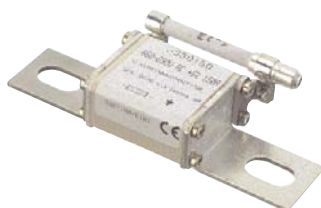

EXTREMELY HIGH BREAKING CAPACITY FUSES: PROTECTION OF POWER SEMICONDUCTORS AS PER IEC STANDARD 60269.1 AND 4 690 V VOLTAGE RATING (RATINGS 50 TO 500 A)

gR CLASS (gRB RATINGS 50 AND 65 A) COMPLYING WITH VDE 636-23

- CLEARING ALL OVERLOADS
- IMPROVED SAFETY AND PROTECTION
- ENABLING SELECTIVE COORDINATION WITH ALL FUSES

aR CLASS (URC AND URD RATINGS 75 TO 500 A) ACCORDING TO VDE 636-23 AND IEC 60269.4

FOUR MODELS: SINGLE AND TWIN BODY AS PER BS 88-4 STANDARD ; Z2 DRAWING (92 mm BETWEEN AXES) WITHOUT BLOWN FUSE INDICATOR - WITH SEPARATE TRIP-INDICATOR

These fuses are UL Recognized 

## Main Characteristics

Voltage rating $U_N$ (V)	Size	Class	Current rating $I_N$ (A)	Pre-arcing $I^2t @ 1 \text{ ms}$ $I^2t_p$ (A <sup>2</sup> s)	Total clearing $I^2t @ 660 \text{ V}$ $I^2t_t$ (A <sup>2</sup> s)	Watts loss		Tested Breaking capacity	Estimated Breaking capacity
						0.8 $I_N$	$I_N$		
690	000	gRB	50	102	730	7.7	14	200 kA @ 690 V	300 kA @ 690 V
			65	210	1500	8.8	16		
		URC	75	390	2500	9.4	17		
			85	540	3300	10.5	19		
			90	690	4200	13.2	24		
			110	1300	8900	13.8	25		
			150	2700	16000	14.3	26		
			180	5250	31500	14.9	27		
	URD	200	9900	52000	15.4	28			
		250	15500	82000	17.6	32			
	280	15500	82000	23.7	43				
	2.000	URC	175	2760	16800	18.2	33	200 kA @ 690 V	300 kA @ 690 V
			200	3800	25000	20.4	37		
			235	5200	35600	24.2	44		
			300	10800	64000	28.6	52		
			325	15400	92400	29.1	53		
355			21000	126000	29.7	54			
400			39600	208000	30.8	56			
450			40000	210000	33	60			
500	62000	328000	35.2	64					

Minimum operating voltage for separate trip-indicator: 20 V



## Other Protistor® Fuses

### BS88-4 Fuses

### 000, 2.000 BS88Z - 690 VAC

#### British standard without blown fuse indicator



Current rating	Designation	Ref. Number	Catalog Number
50	6,9 gRB 000 BS88Z/050	V330137	BZ000GB69V50
65	6,9 gRB 000 BS88Z/065	W330138	BZ000GB69V65
75	6,9 URC 000 BS88Z/075	X330139	BZ000UC69V75
85	6,9 URC 000 BS88Z/085	Y330140	BZ000UC69V85
90	6,9 URC 000 BS88Z/090	Z330141	BZ000UC69V90
110	6,9 URC 000 BS88Z/110	A330142	BZ000UC69V110
150	6,9 URC 000 BS88Z/150	B330143	BZ000UC69V150
180	6,9 URC 000 BS88Z/180	C330144	BZ000UC69V180
200	6,9 URD 000 BS88Z/200	D330145	BZ000UD69V200
250	6,9 URD 000 BS88Z/250	E330146	BZ000UD69V250
280	6,9 URC 000 BS88Z/280	F330147	BZ000UC69V280

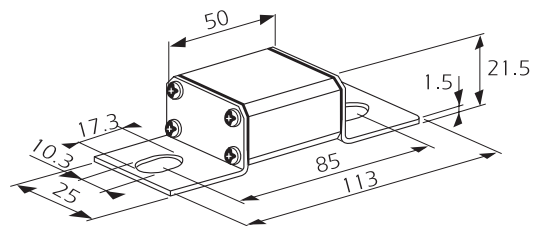

Weight: 140 g  
Packaging: 3 pieces

175	6,9 URC 2000 BS88Z/175	P330155	BZ2000UC69V175
200	6,9 URC 2000 BS88Z/200	Q330156	BZ2000UC69V200
235	6,9 URC 2000 BS88Z/235	R330157	BZ2000UC69V235
300	6,9 URC 2000 BS88Z/300	S330158	BZ2000UC69V300
325	6,9 URC 2000 BS88Z/325	T330159	BZ2000UC69V325
355	6,9 URC 2000 BS88Z/355	V330160	BZ2000UC69V355
400	6,9 URD 2000 BS88Z/400	W330161	BZ2000UD69V400
450	6,9 URC 2000 BS88Z/450	X330162	BZ2000UC69V450
500	6,9 URD 2000 BS88Z/500	Y330163	BZ2000UD69V500

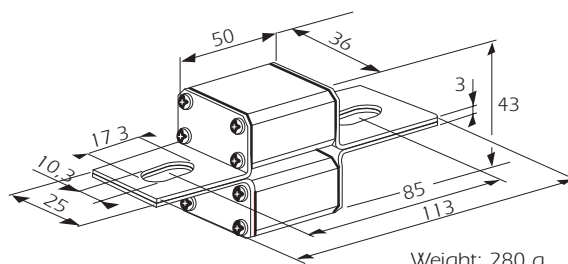

Weight: 280 g  
Packaging: 3 pieces

#### British standard with separate trip-indicator



Current rating	Designation	Ref. Number	Catalog Number
90	6,9 URC 000 BS88ZP090	G330148	BZ000UC69V90P
110	6,9 URC 000 BS88ZP110	H330149	BZ000UC69V110P
150	6,9 URC 000 BS88ZP150	J330150	BZ000UC69V150P
180	6,9 URC 000 BS88ZP180	K330151	BZ000UC69V180P
200	6,9 URD 000 BS88ZP200	L330152	BZ000UD69V200P
250	6,9 URD 000 BS88ZP250	M330153	BZ000UD69V250P
280	6,9 URC 000 BS88ZP280	N330154	BZ000UC69V280P

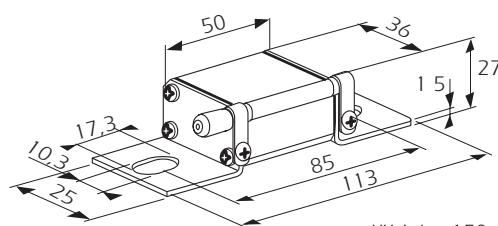

Weight: 150 g  
Packaging: 3 pieces

175	6,9 URC 2000 BS88ZP175	Z330164	BZ2000UC69V175P
200	6,9 URC 2000 BS88ZP200	A330165	BZ2000UC69V200P
235	6,9 URC 2000 BS88ZP235	B330166	BZ2000UC69V235P
300	6,9 URC 2000 BS88ZP300	C330167	BZ2000UC69V300P
325	6,9 URC 2000 BS88ZP325	D330168	BZ2000UC69V325P
355	6,9 URC 2000 BS88ZP355	E330169	BZ2000UC69V355P
400	6,9 URD 2000 BS88ZP400	F330170	BZ2000UD69V400P
450	6,9 URC 2000 BS88ZP450	G330171	BZ2000UC69V450P
500	6,9 URD 2000 BS88ZP500	H330172	BZ2000UD69V500P

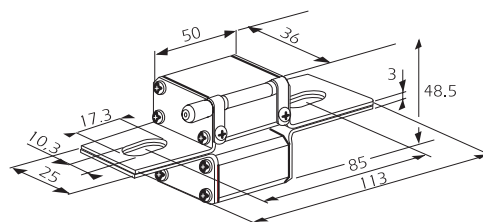

Weight: 290 g  
Packaging: 3 pieces

The use of MC 6.3 GR 2-5N blown fuse remote sensing microswitch is possible.  
Ref. Number: Y 310015 mounted on separate trip-indicator.

## Other Protistor® Fuses

### BS88-4 Fuses

### 000, 2.000 BS88Z - 690 VAC

#### Total clearing $I^2t$

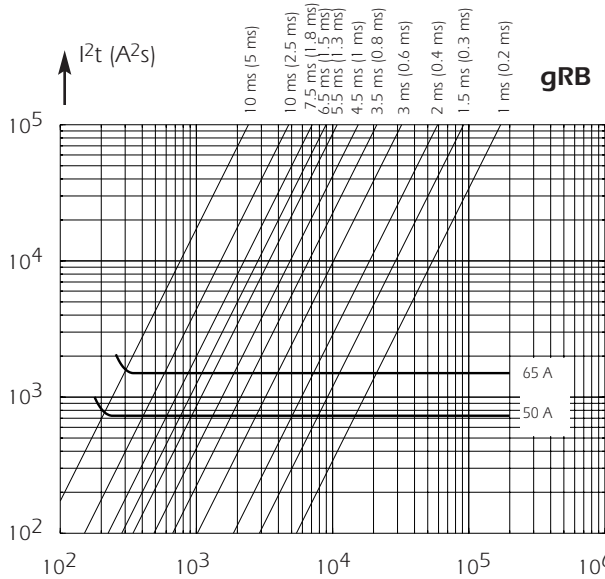

Above and right: Horizontal curves show, for each rated current, maximum values of total clearing  $I^2t$  ( $I^2t_t$ ) as a function of prospective current  $I_p$  @ UN with  $\cos \varphi = 0.15$ . Oblique lines indicate total clearing duration  $T_t$ , with associated pre-arcing duration in brackets.

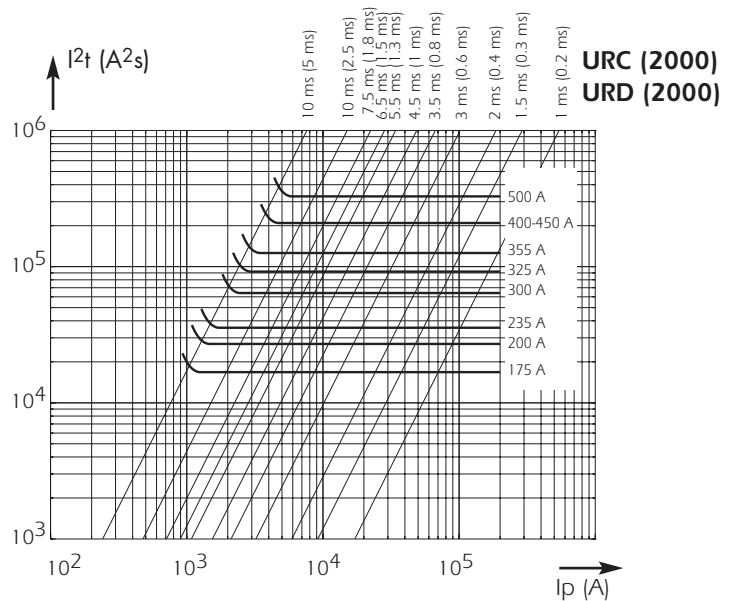
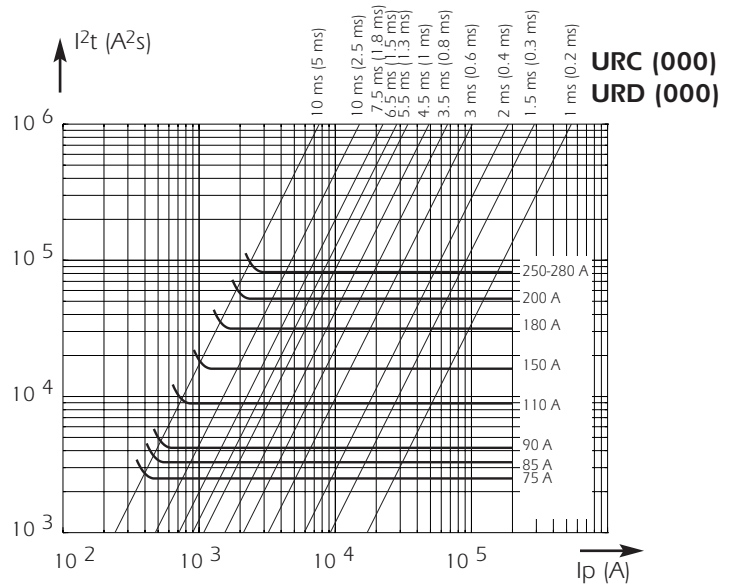

#### $I^2t$ corrective factor

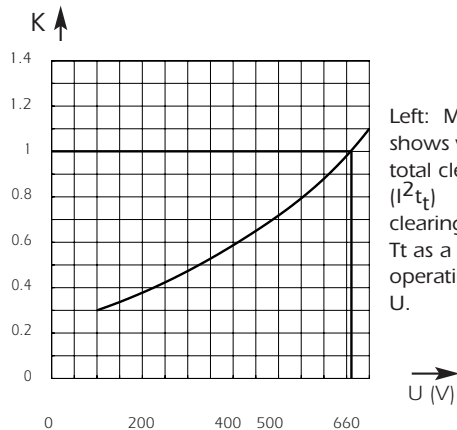

Left: Mean curve shows variation of total clearing time ( $I^2t_t$ ) and total clearing duration  $T_t$  as a function of operating voltage  $U$ .

#### Peak arc voltage

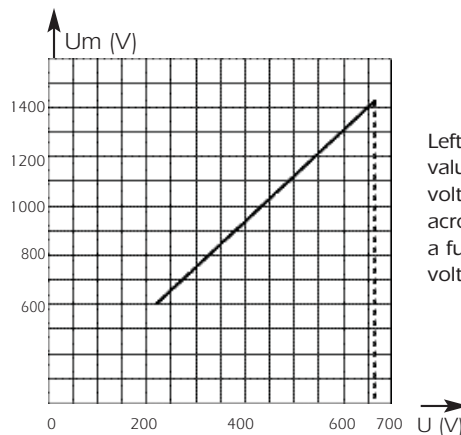

Left: Curve shows peak value  $U_m$  of the arc voltage which appears across fuse-link as a function of operating voltage  $U$  @  $\cos \varphi = 0.15$

#### Watts loss

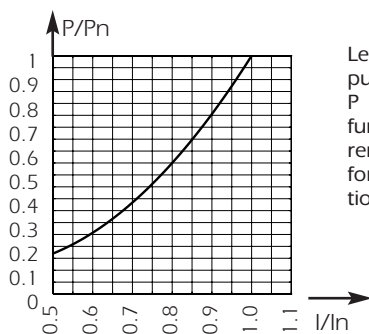

Left: Curve enables computation of power losses  $P$  for  $I_N$ -rated fuse as a function of R.M.S. current  $I$  (as a multiple of  $I_N$  for steady state operation)

# Semiconductor (AC) fuses



## Other Protistor® Fuses

### BS88-4 Fuses

### 000, 2.000 BS88Z - 690 VAC

#### DC Application data

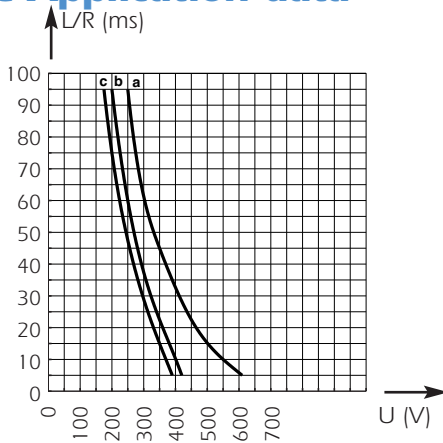

Above: Curves indicate permissible value of time constant  $L/R$  as a function of DC working voltage.  
 Curve a: Ratings from 175 to 300 A  
 Curve b: Rating 325 A  
 Curve c: Ratings from 355 to 500 A

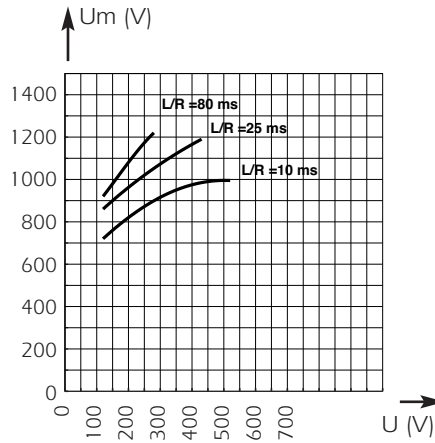

Above: Curves indicate peak arc voltage  $U_m$  which may appear across fuse terminals at working voltage  $U$ .

Rated current	Curve	$I_{pm}$ (A)
50	a	150
65	a	200
75	a	270
85	a	350
90	a	370
110	a	500
150	a	700
180	b	1200
200	c	1800
250	c	2200
280	c	2200
175	a	740
200	a	870
235	a	1000
300	a	1400
325	b	1900
355	b	2400
400	c	3600
450	c	4400
500	c	4400

$I_{pm}$  values give minimum DC interrupting current in amps.

#### Current limitation curves

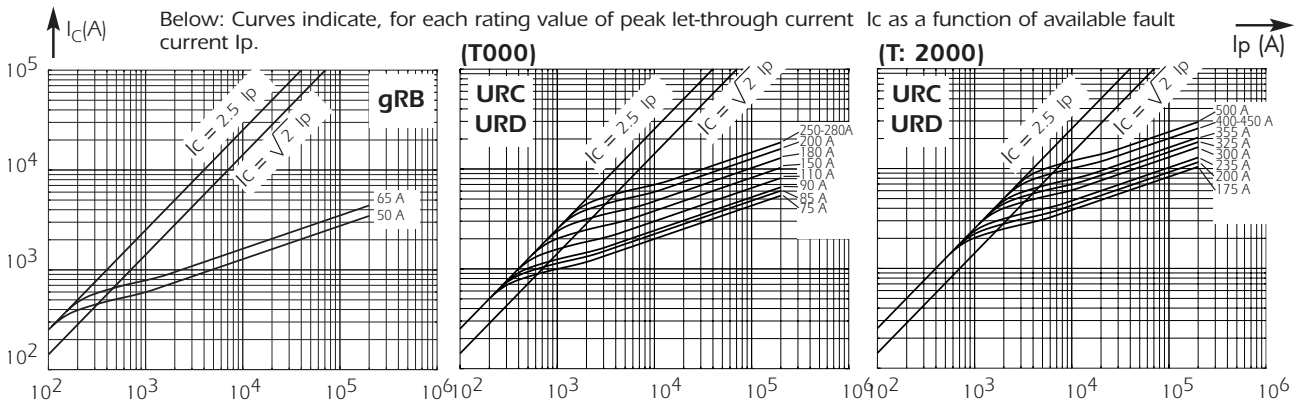

Below: Curves indicate, for each rating value of peak let-through current  $I_c$  as a function of available fault current  $I_p$ .

#### Time vs current characteristics

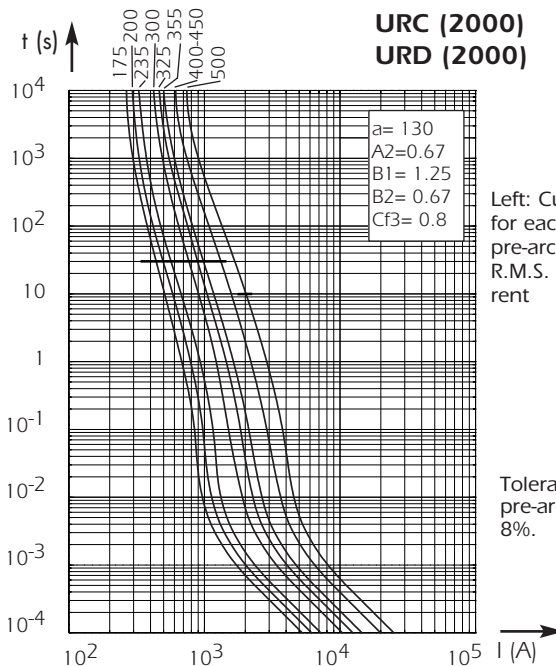
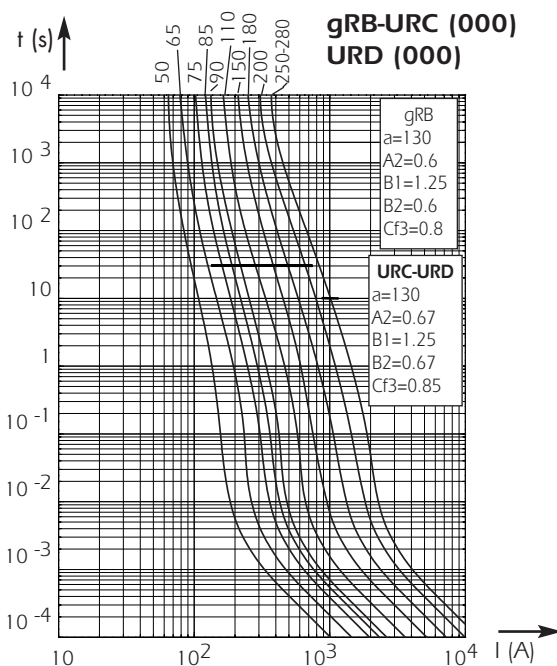

Left: Curves indicate, for each rated current, pre-arcing time vs. R.M.S. pre-arcing current

Tolerance for mean pre-arcing current  $\pm 8\%$ .

## Other Protistor® Fuses BS88-4 Fuses

### Microswitches for BS88-4 Protistor®

MICROSWITCH SYSTEMS ADAPTED  
TO THE FOLLOWING FUSES:

- BS88 - 4 separated trip-indicator
- BS88 - 4 built-in trip-indicator

### Main Characteristics

Code	AC Insulation voltage rating (***)	Positive operating voltage/current	Current rating	Current	Interrupting rating						AC voltage withstand test (*)	Impulse voltage test Uimp1.2/50 μs (**)	Fire class according to UL 94
					Non inductive circuit			Inductive circuit : L/R = 25ms					
					30V	110V	250V	30V	110V	250V			
MC 6,3 GR 2-5 N	1000 V	20 V 100 mA	5 A	50/60 Hz	-	5 A	0,3 A	-	3 A	2 A	3.5 kV	-	H.B.
				DC	4 A	0.4 A	-	3 A	0.4 A	-			
MC 36 GR 2-5	1000 V	20 V 100 mA	5 A	50/60 Hz	-	5 A	5 A	-	5 A	5 A	7.5 kV	-	
				DC	4 A	0.4 A	-	2 A	0.4 A	-			

\* Between power circuit and microswitch terminals as per IEC 60 and 694 (50/60 Hz 1 min duration in dry air)

\*\* Between power circuit and microswitch terminals Uimp: impulse voltage as per IEC 947-1

\*\*\* Between power circuit and microswitch terminals

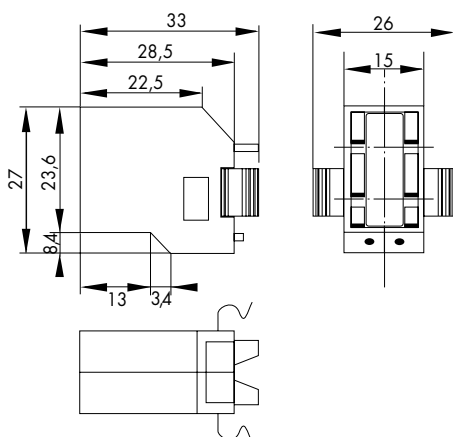
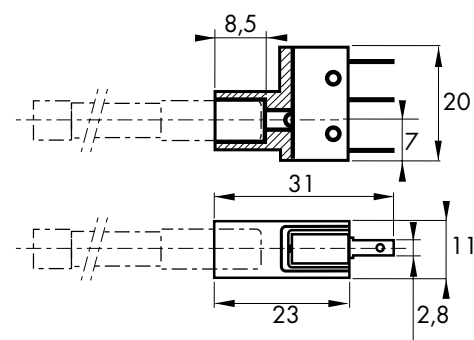

Catalog Number	Ref. Number	Weight (g)	Pack.
MC 6,3 GR 2-5 N (for separate trip-indicator)	Y 310015	10	3

Catalog Number	Ref. Number	Weight (g)	Pack.
MC 36 GR 2-5 (for built-in trip-indicator)	P 092496	10	3