

## DC Square-body Fuses Sizes 120 to 123 gR 750V DC

Size 120  
gRC from 200 to 250 A

### Dimensions

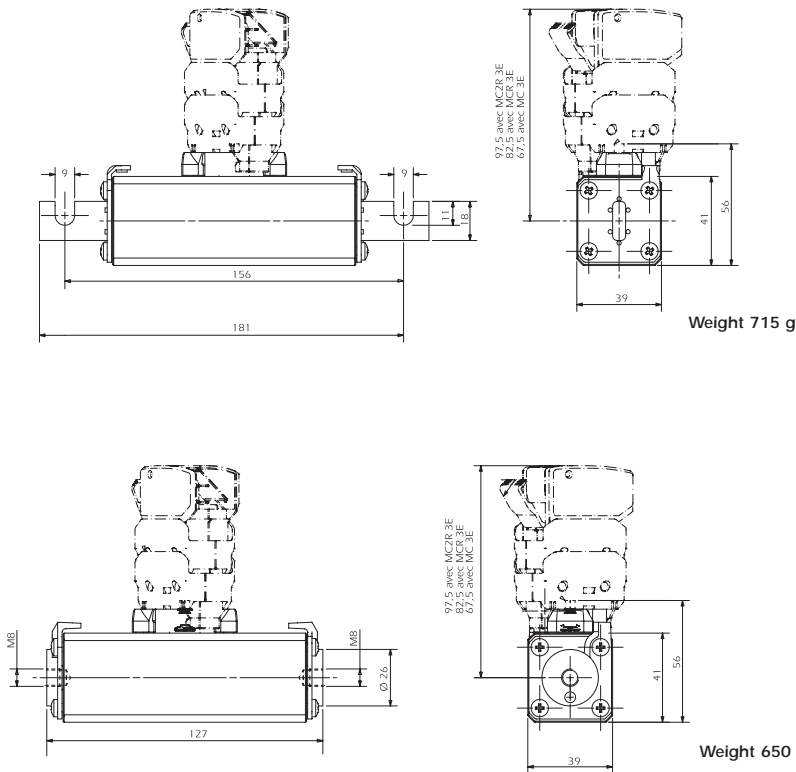

### Main Characteristics

Size	Current rating $I_N$ (A)	Breaking capacity	Watts loss		Max. $I^2t$		Designation	Ref. Number	Catalog Number
			$0.8 I_N$ (W)	$I_N$ (W)	@ 900 V = L/R 40 ms $IP = 10 I_N$ (A <sup>2</sup> S)	$IP = 50 I_N$ (A <sup>2</sup> S)			
120	50	@ 750 V= 100k A L/R = 100 ms	4.4	8.1	42500	8500	CC 7,5 gRC 120 EF 0050	Y084776	D120GC75V50EF
	63		5.7	10.4	75500	15000	CC 7,5 gRC 120 EF 0063	R085207	D120GC75V63EF
	80		7.3	13.4	125000	24500	CC 7,5 gRC 120 EF 0080	Q085206	D120GC75V80EF
	100		9.1	16.7	200000	40000	CC 7,5 gRC 120 EF 0100	P085205	D120GC75V100EF
	125		11.5	21	315000	62500	CC 7,5 gRC 120 EF 0125	R086242	D120GC75V125EF
	160		15	27	485000	100000	CC 7,5 gRC 120 EF 0160	N085204	D120GC75V160EF
	50	@ 900 V= 100k A L/R = 40 ms	4.4	8.1	42500	8500	CC 7,5 gRC 120 TTF 0050	B220824	D120GC75V50TF
	63		5.7	10.4	75500	15000	CC 7,5 gRC 120 TTF 0063	Q082400	D120GC75V63TF
	80		7.3	13.4	125000	24500	CC 7,5 gRC 120 TTF 0080	Z090435	D120GC75V80TF
	100		9.1	16.7	200000	40000	CC 7,5 gRC 120 TTF 0100	R082401	D120GC75V100TF
	125		11.5	21	315000	62500	CC 7,5 gRC 120 TTF 0125	P085251	D120GC75V125TF
	160		15	27	485000	100000	CC 7,5 gRC 120 TTF 0160	R085253	D120GC75V160TF

Microswitch: MC 3E 1-5N Ref. Number: D310020

Pack: 1 piece



## DC Square-body Fuses Sizes 120 to 123 gR 750V DC



size 120  
gRC from 200 to 250 A

### Electrical characteristics DC applications data

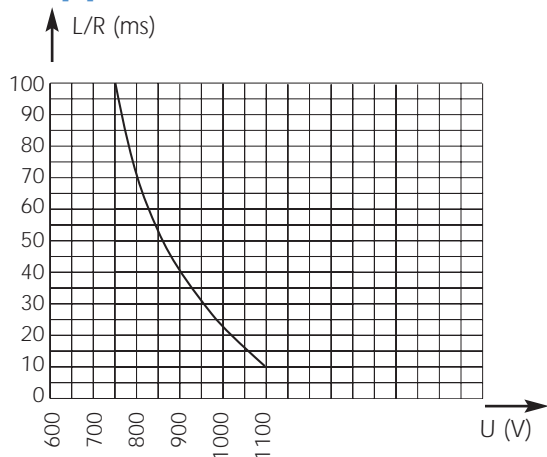

Above: Curve indicates maximum permissible value of time constant L/R as a function of DC working voltage

**Max. AC voltage (50/60 Hz):**  
1250 V with breaking capacity of 170 kA

### Peak arc voltage vs. working voltage

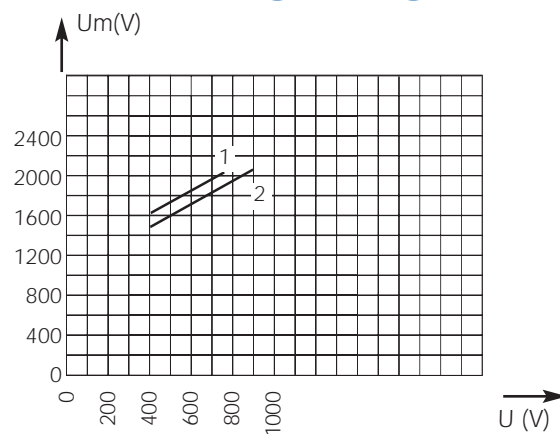

1 : L/R = 100 ms  
2 : L/R = 40 ms

Above: Curves indicate for various time constants L/R the peak arc voltage which may appear across fuse terminals, vs. DC working voltage

### Time vs. current characteristics

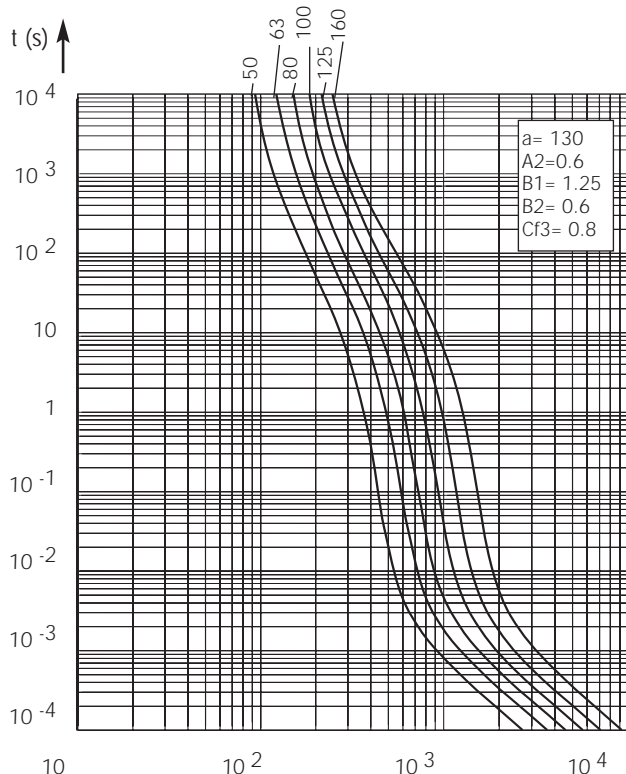

± 7% tolerance for mean pre-arcing current

I (A)

Above: Curves indicate, for each rated current, pre-arcing time vs. R.M.S. pre-arcing current.

## DC Square-body Fuses Sizes 120 to 123 gR 750V DC

Sizes 121  
gRC from 200 to 250 A

### Dimensions

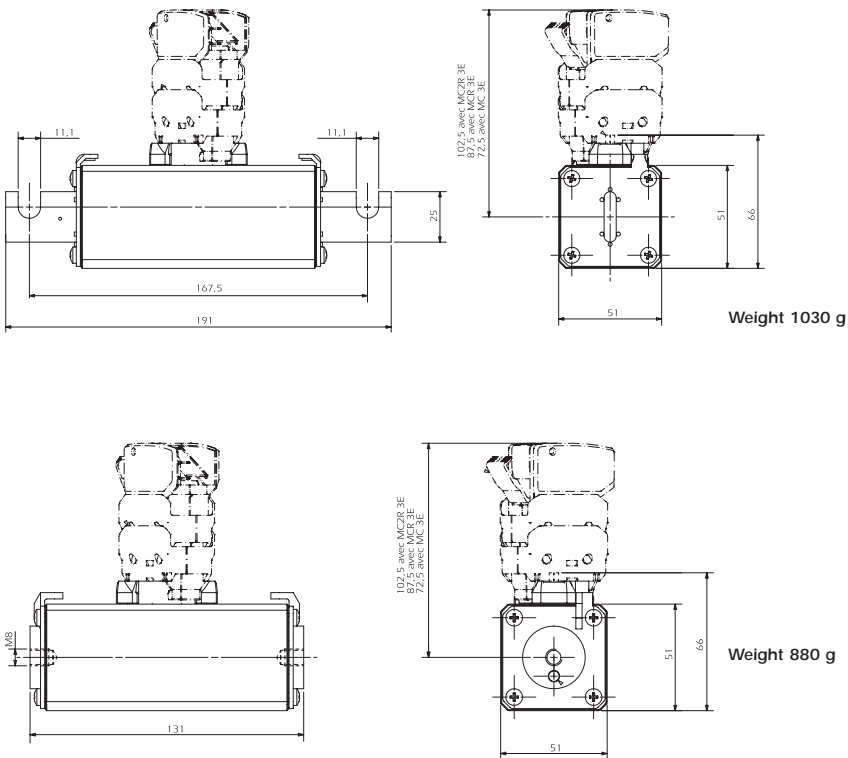

### Main Characteristics

Size	Current rating $I_N$ (A)	Breaking Capacity	Watts loss		Max. $I^2t$		Designation	Ref. Number	Catalog Number
			$0.8 I_N$ (W)	$I_N$ (W)	@ 900 V = L/R 40 ms $IP = 10 I_N$ (A <sup>2</sup> S)	$IP = 50 I_N$ (A <sup>2</sup> S)			
121	200	@750 V DC	20.5	37.5	755000	150000	CC 7,5 gRC 121 EF 0200	A086710	D121GC75V200EF
	250	100 kA	25.5	46.7	1250000	250000	CC 7,5 gRC 121 EF 0250	M085203	D121GC75V250EF
		L/R = 100 ms							
	200	@ 900 V DC	20.5	37.5	755000	150000	CC 7,5 gRC 121 TTF 0200	N085250	D121GC75V200TF
	250	100 kA	25.5	46.7	1250000	250000	CC 7,5 gRC 121 TTF 0250	Q085252	D121GC75V250TF
		L/R = 40 ms							

Microswitch: MC 3E 1-5N Ref. Number: D310020

Pack: 1 piece



## DC Square-body Fuses Sizes 120 to 123 gR 750V DC

Sizes 121  
gRC from 200 to 250 A

### Electrical characteristics

#### DC applications data

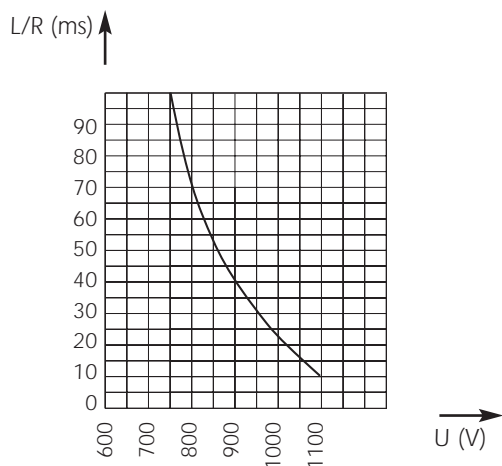

Above: Curve indicates maximum permissible value of time constant  $L/R$  as a function of DC working voltage

**Max. AC voltage (50/60 Hz):**  
1250 V with breaking capacity of 170 kA

#### Peak arc voltage vs. working voltage

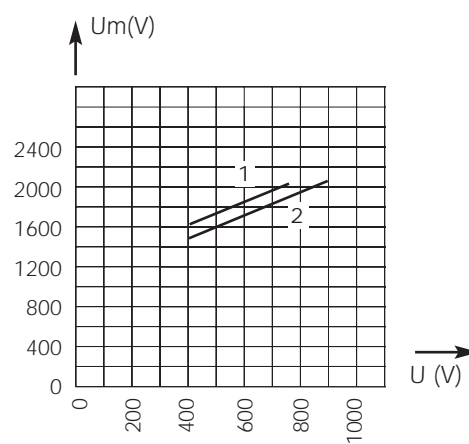

1 :  $L/R = 100$  ms  
2 :  $L/R = 40$  ms

Above: Curves indicate for various time constants  $L/R$  the peak arc voltage which may appear across fuse terminals, vs. DC working voltage

#### Time vs. current characteristics

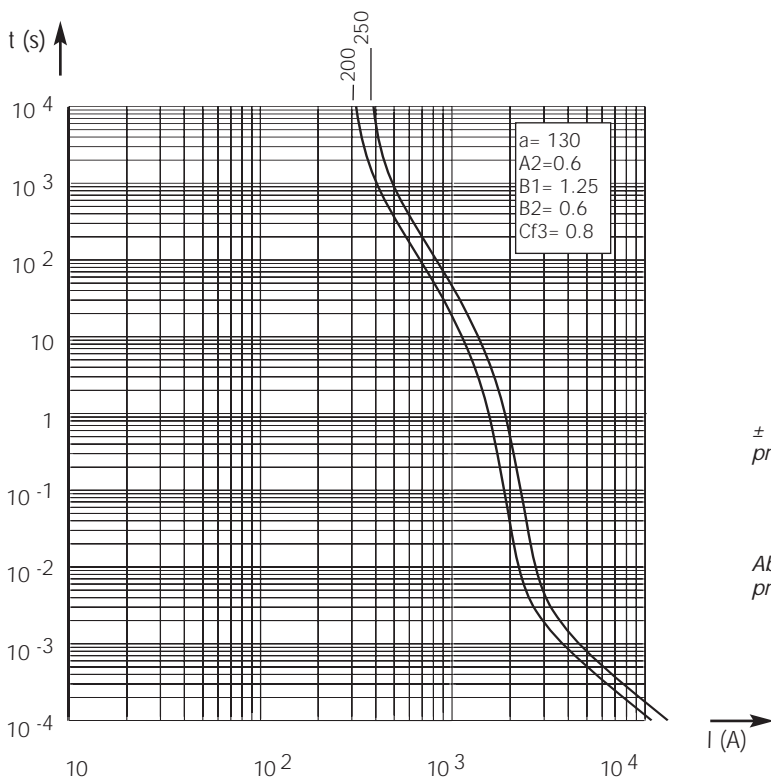

$\pm 7\%$  tolerance for mean pre-arcing current

Above: Curves indicate, for each rated current, pre-arcing time vs. R.M.S. pre-arcing current.

## DC Square-body Fuses Sizes 120 to 123 gR 750V DC

Size 122  
gRC-gRD from 250 to 500 A

### Dimensions

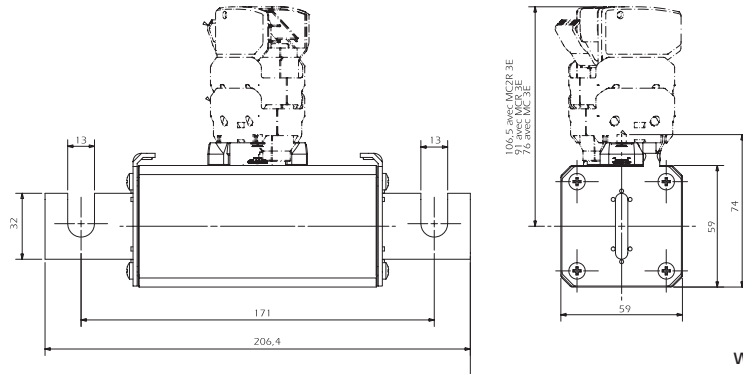

Weight: 1300 g

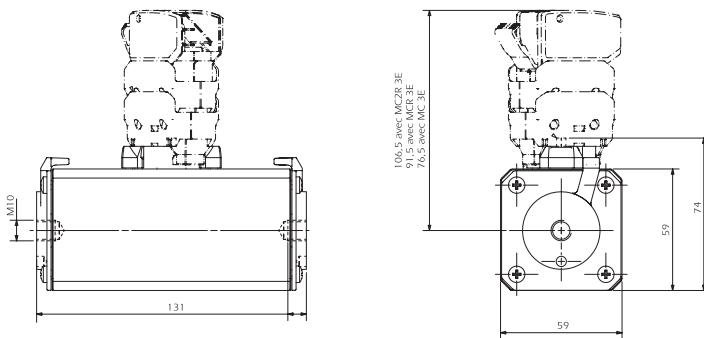

Weight: 1150 g



### Main Characteristics

Size	Current rating $I_N$ (A)	Breaking Capacity	Watts loss		Max. $I^2t$		Designation	Ref. Number	Catalog Number
			0.8 $I_N$ (W)	$I_N$ (W)	@ 900 V = L/R 40 ms $I^2t$ (A <sup>2</sup> S)	P = 50 $I_N$ (A <sup>2</sup> S)			
122	250	@750 V DC 100 kA L/R = 100 ms	25.5	46.7	1.25 10 <sup>6</sup>	250,000	CC 7,5 gRC 122 EF 0250	A087331	D122GC75V250EF
	315		31.5	58	2 10 <sup>6</sup>	400,000	CC 7,5 gRC 122 EF 0315	B087332	D122GC75V315EF
	350		35	64.5	2.5 10 <sup>6</sup>	500,000	CC 7,5 gRC 122 EF 0350	W221141	D122GC75V350EF
	400		40.5	74.5	3.1 10 <sup>6</sup>	600,000	CC 7,5 gRC 122 EF 0400	L089388	D122GC75V400EF
	450		49	90	4 10 <sup>6</sup>	800,000	CC 7,5 gRD 122 EF 0450	P220951	D122GD75V450EF
	500*		52	95	6.2 10 <sup>6</sup> *	1.2 10 <sup>6</sup> *	CC 7,5 gRD 122 EF 0500*	Q220952	D122GD75V500EF
	250	@ 900 V DC 100 kA L/R = 40 ms	25.5	46.7	1.25 10 <sup>6</sup>	250,000	CC 7,5 gRC 122 TTF 0250	B090437	D122GC75V250TF
	315		31.5	58	2 10 <sup>6</sup>	400,000	CC 7,5 gRC 122 TTF 0315	M085249	D122GC75V315TF
	350		35	64.5	2.5 10 <sup>6</sup>	500,000	CC 7,5 gRC 122 TTF 0350	G220898	D122GC75V350TF
	400		40.5	74.5	3.1 10 <sup>6</sup>	600,000	CC 7,5 gRC 122 TTF 0400	C090438	D122GC75V400TF
	450		49	90	4 10 <sup>6</sup>	800,000	CC 7,5 gRD 122 TTF 0450	R220953	D122GD75V450TF
	500*		52	95	6.2 10 <sup>6</sup> *	1.2 10 <sup>6</sup> *	CC 7,5 gRD 122 TTF 0500*	S220954	D122GD75V500TF

\* Max.  $I^2t$  @ 800 V=, L/R=40 ms and Breaking capacity = 100 kA @ 750VDC/50ms

Microswitch: MC 3E 1-5N Ref. Number: D310020

Pack: 1 piece



## DC Square-body Fuses Sizes 120 to 123 gR 750V DC

Size 122  
gRC-gRD from 250 to 500 A

### Electrical characteristics DC applications data

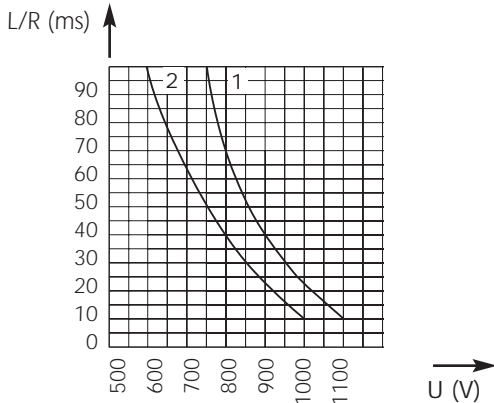

1: curve gRC - gRD 450A  
2: curve gRD 500A

Above: Curves indicate maximum permissible value of time constant L/R as a function of DC working voltage

Max. AC voltage (50/60 Hz):  
1250 V with breaking capacity of 170 kA

### Time vs. current characteristics

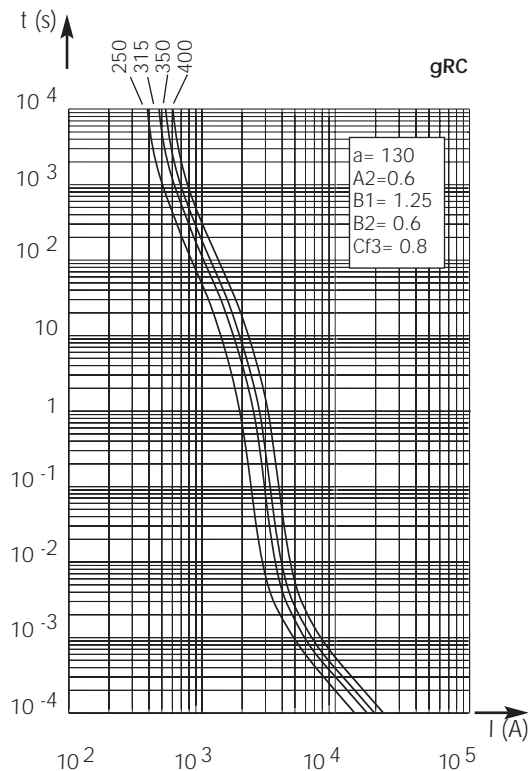

Above: Curves indicate, for each rated current, pre-arcing time vs. R.M.S. pre-arcing current.

### Peak arc voltage vs. working voltage

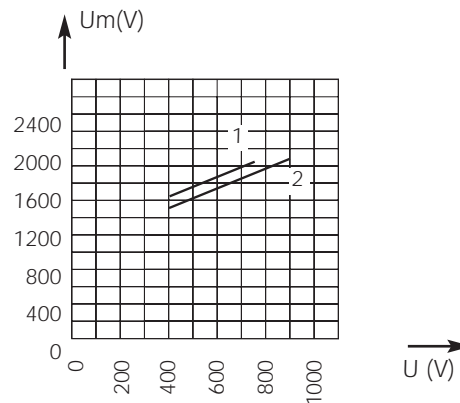

1: L/R = 100 ms  
2: L/R = 40 ms

Above: Curves indicate for various time constants L/R the peak arc voltage which may appear across fuse terminals, vs. DC working voltage

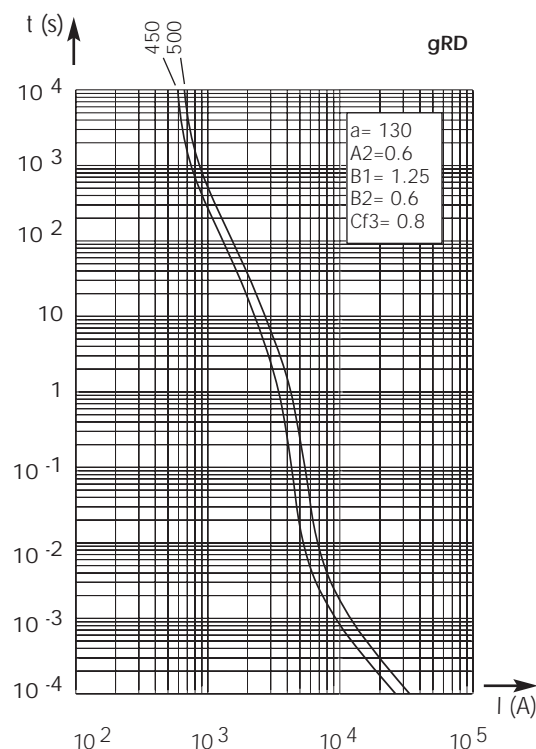

± 7% tolerance for mean pre-arcing current

## DC Square-body Fuses Sizes 120 to 123 gR 750V DC

### Size 123 gRB-gRC-gRD from 500 to 800 A

#### Dimensions

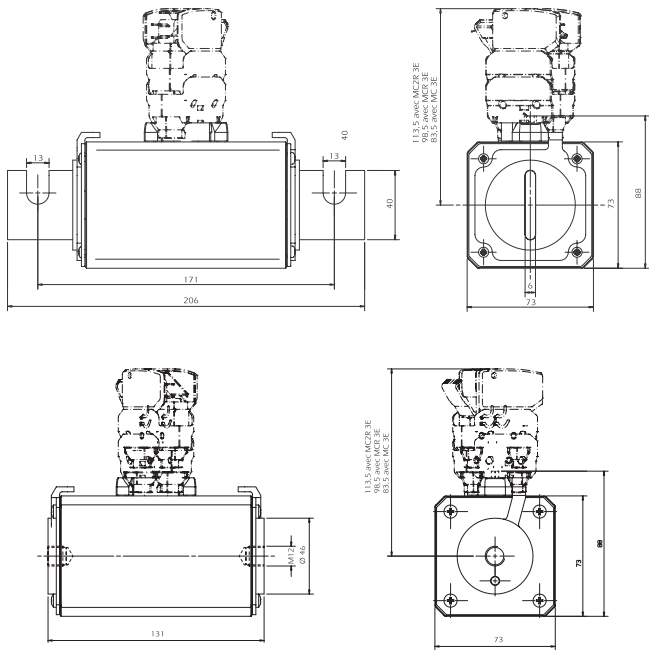

Weight: 2100 g



Weight: 1900 g



#### Main Characteristics

Size	Current rating $I_N$ (A)	Breaking capacity	Watts loss		Max. $I^2t$		Designation	Ref. Number	Catalog Number	
			0.8 $I_N$ (W)	$I_N$ (W)	@ 900 V = L/R 40 ms $I_p = 10 I_N$ (A <sup>2</sup> s)	$I_p = 50 I_N$ (A <sup>2</sup> s)				
123	500	@ 750 V DC 100 kA L/R = 100 ms	51	93.5	5 10 <sup>6</sup>	1 10 <sup>6</sup>	CC 7,5 gRC 123 EF 0500	M089389	D123GC75V500EF	
		@ 900 V DC 100 kA L/R = 40 ms	51	93.5	5 10 <sup>6</sup>	1 10 <sup>6</sup>	CC 7,5 gRC 123 TTF 0500	D090439	D123GC75V500TF	
	630 700 750	@ 750 V DC 100 kA L/R = 50 ms	See max. operating current next page	74 82 82	74 82 82	maximum $I^2t$ (A <sup>2</sup> s) @ 800 V = L/R 40 ms $I_p = 10 I_N$   $I_p = 50 I_N$		CC 7,5 gRB 123 EF 0630	B098556	D123GB75V630EF
						10 10 <sup>6</sup>	2 10 <sup>6</sup>	CC 7,5 gRB 123 EF 0700	Q078191	D123GB75V700EF
						10 10 <sup>6</sup>	2 10 <sup>6</sup>	CC 7,5 gRD 123 EF 0750	F220943	D123GD75V750EF
						7.5 10 <sup>6</sup>	1.5 10 <sup>6</sup>	CC 7,5 gRB 123 TTF 0630	C098557	D123GB75V630TF
						10 10 <sup>6</sup>	2 10 <sup>6</sup>	CC 7,5 gRB 123 TTF 0700	F090441	D123GB75V700TF
						10 10 <sup>6</sup>	2 10 <sup>6</sup>	CC 7,5 gRD 123 TTF 0750	H220945	D123GB75V750TF
	800	@ 660 V DC 100 kA L/R = 50 ms	90 90	90 90	maximum $I^2t$ (A <sup>2</sup> s) @ 660 V = L/R 30 ms $I_p = 10 I_N$   $I_p = 50 I_N$		CC 6.6 gRB 123 EF 0800	G220944	D123GB66V800EF	
					12.15 10 <sup>6</sup>	2.6 10 <sup>6</sup>	CC 6.6 gRB 123 TTF 0800	J220946	D123GB66V800TF	

Microswitch: MC 3E 1-5N Ref. Number: D310020

Pack: 1 piece



## DC Square-body Fuses Sizes 120 to 123 gR 750V DC

Size 123  
gRB-gRC-gRD from 500 to 800 A

### Electrical characteristics

### DC applications data

### Peak arc voltage vs. working voltage

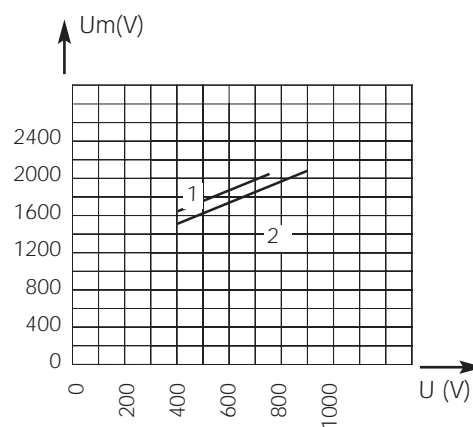
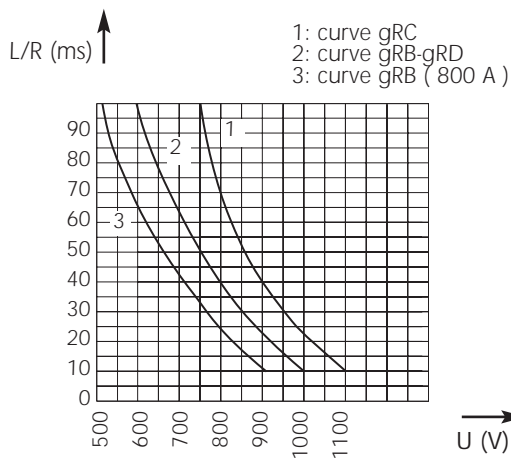

Above: Curves indicate maximum permissible value of time constant L/R as a function of DC working voltage

1: L/R = 100 ms  
2: L/R = 40 ms

**Max. AC voltage (50/60 Hz):**  
1250 V with breaking capacity of 170 kA

Above: Curves indicate for various time constants L/R the peak arc voltage which may appear across fuse terminals, vs. DC working voltage

### Time vs. current characteristics

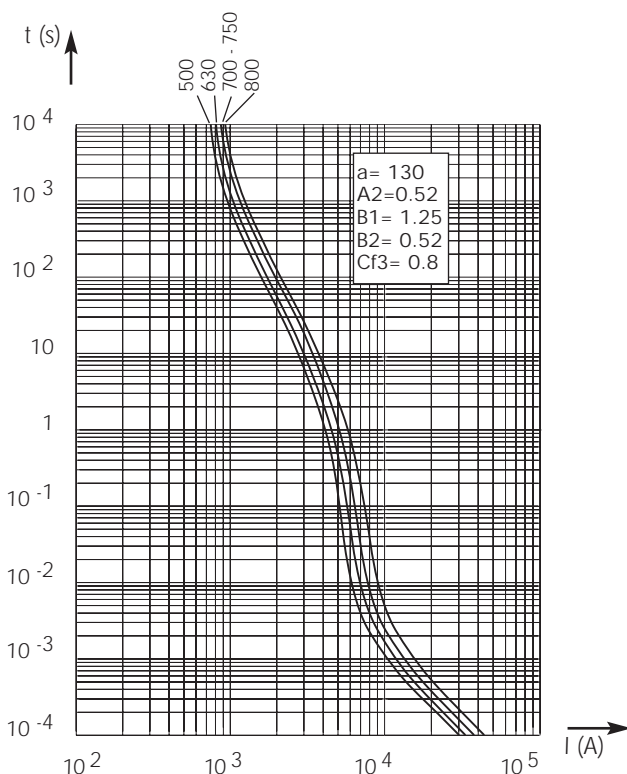

Current rating (A)	550	600	650	Maximum operating current (A)
630				
700				
750				
800				

± 7% tolerance for mean pre-arcing current

Above: curves indicate, for each rated current, pre-arcing time vs. R.M.S. pre-arcing current