



Page 8-2

SIGNAL TOWERS

- Signal towers Ø70mm
- Steady, blinking light or flash modules
- Pulsed or continuous sound modules
- Incandescent and LED bulbs.



Page 8-3

SIGNAL BEACONS

- Signal beacons Ø62mm
- Blinking or steady light modules
- Sound-light pulsed or continuous modules
- Incandescent and LED bulbs.



Signal towers Ø70mm

- Modular and combinations up to 7 modules
- Steady or blinking light, pulsed or continuous sound modules.

Signal beacons Ø62mm

- Steady or blinking light, pulsed or continuous sound modules.

Signal towers and beacons

SEC. - PAGE

Signal towers Ø70mm	8 - 2
Signal beacons Ø62mm	8 - 3
Accessorios	8 - 4
Dimensions	8 - 6
Wiring diagrams	8 - 7

Signal towers Ø70mm



LT7 EL ...
LT7 GL ...
LT7 FL ...



LT7 S ...



LT7 CM 01
LT7 CP 01

Order code	Description	Qty per pkg	Wt
		n°	[kg]

Steady light modules BA15d fitting, direct supply.
Bulb (8 LT7 ALB... and 8 LT7 ALL...) not included.

8 LT7 EL1	Orange	1	0.082
8 LT7 EL3	Green	1	0.082
8 LT7 EL4	Red	1	0.082
8 LT7 EL5	Yellow	1	0.082
8 LT7 EL6	Blue	1	0.082
8 LT7 EL8	White	1	0.082

Blinking light modules. BA15d fitting.
Bulb (8 LT7 ALB... and 8 LT7ALL...) not included.

8 LT7 GL B1	Orange, 24VAC/DC	1	0.083
8 LT7 GL B3	Green, 24VAC/DC	1	0.083
8 LT7 GL B4	Red, 24VAC/DC	1	0.083
8 LT7 GL B5	Yellow, 24VAC/DC	1	0.083
8 LT7 GL B6	Blue, 24VAC/DC	1	0.083
8 LT7 GL B8	White, 24VAC/DC	1	0.083
8 LT7 GL E1	Orange, 110-120VAC	1	0.083
8 LT7 GL E3	Green, 110-120VAC	1	0.083
8 LT7 GL E4	Red, 110-120VAC	1	0.083
8 LT7 GL E5	Yellow, 110-120VAC	1	0.083
8 LT7 GL E6	Blue, 110-120VAC	1	0.083
8 LT7 GL E8	White, 110-120VAC	1	0.083
8 LT7 GL M1	Orange, 230-240VAC	1	0.083
8 LT7 GL M3	Green, 230-240VAC	1	0.083
8 LT7 GL M4	Red, 230-240VAC	1	0.083
8 LT7 GL M5	Yellow, 230-240VAC	1	0.083
8 LT7 GL M6	Blue, 230-240VAC	1	0.083
8 LT7 GL M8	White, 230-240VAC	1	0.083

Flash modules. With 4-Joule xenon bulb.

8 LT7 FL B1	Orange, 24VAC/DC	1	0.092
8 LT7 FL B3	Green, 24VAC/DC	1	0.092
8 LT7 FL B4	Red, 24VAC/DC	1	0.092
8 LT7 FL B5	Yellow, 24VAC/DC	1	0.092
8 LT7 FL B6	Blue, 24VAC/DC	1	0.092
8 LT7 FL B8	White, 24VAC/DC	1	0.092
8 LT7 FL E1	Orange, 110-120VAC	1	0.092
8 LT7 FL E3	Green, 110-120VAC	1	0.092
8 LT7 FL E4	Red, 110-120VAC	1	0.092
8 LT7 FL E5	Yellow, 110-120VAC	1	0.092
8 LT7 FL E6	Blue, 110-120VAC	1	0.092
8 LT7 FL E8	White, 110-120VAC	1	0.092
8 LT7 FL M1	Orange, 230-240VAC	1	0.092
8 LT7 FL M3	Green, 230-240VAC	1	0.092
8 LT7 FL M4	Red, 230-240VAC	1	0.092
8 LT7 FL M5	Yellow, 230-240VAC	1	0.092
8 LT7 FL M6	Blue, 230-240VAC	1	0.092
8 LT7 FL M8	White, 230-240VAC	1	0.092

Pulsed or continuous sound modules complete with cover.

8 LT7 S0 B	24VAC/DC, pulsed (90dB). IP54 protection	1	0.240	
8 LT7 S1 B	24VAC/DC, 16 sound tones (80dB max). IP65 protection	1	0.240	
8 LT7 S2 B	24VAC/DC	pulsed (78dB) ^①	1	0.240
8 LT7 S2 E	110-120VAC	or continuous (75dB) ^② sound	1	0.240
8 LT7 S2 M	230-240VAC	IP65 protection	1	0.240

Connection modules complete with cover.

8 LT7 CP 01	For plastic tubes, black colour, bottom entry	1	0.110
8 LT7 CM 01	For metal tubes, black colour, bottom entry	1	0.120

① 84.5dB for 8 LT7 S2 B.
② 82.6dB for 8 LT7 S2 B.

General characteristics

Signal towers are fundamental elements in manufacturing processes for the visual and audible signalling of the system status.

The signal towers can be assembled by stacking up to 7 modules, in the following sequence, starting from the top: red, yellow, orange, blue, green and white. The sound module, if any, must always be positioned at the top of the signal tower.

Technical characteristics

- Maximum operational voltage: 250V
- Consumption of flash and sound modules:
 - LT7 FL B... in AC: 135mA
 - LT7 FL B... in DC: 75mA
 - LT7 FL E...: 20mA
 - LT7 FL M...: 15mA
 - LT7 S0 B: 25mA
 - LT7 S1 B: 40mA
 - LT7 S2 B: 200mA
 - LT7 S2 E: 40mA
 - LT7 S2 M: 30mA
- Material: Polycarbonate or anodised aluminium
- Connections: Screw clamp terminals, maximum 1.5mm²/16 AWG conductor section
- Tightening torque: 0.5Nm/4.5lbin
- Operating temperature: -20...+50°C; for 12VAC max up to +40°C
- Number of stackable elements: Seven.
- Degree of protection: IP65; IP54 for 8 LT7 S0B sound module.

Certifications and compliance

Certifications obtained: GOST; UL Listed, for USA and Canada (file E318016) as Power Circuit and motor-mounted Apparatus - Stackable tower lights. Compliant with standards: IEC/EN 60947-5-1, IEC/EN 60947-1, UL508, CSA C22.2 n° 14.

Combinations

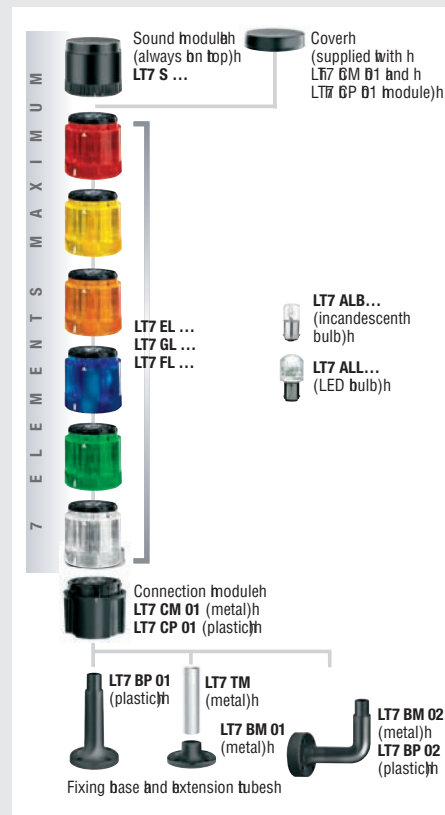

Signal beacons Ø62mm



LB6 EL ...
LB6 GL ...
LB6 S2...

Order code	Description	Qty per pkg	Wt
		n°	[kg]
Steady light modules. BA15d fitting, direct supply. Bulb not included.			
8 LB6 EL1	Orange	1	0.060
8 LB6 EL3	Green	1	0.060
8 LB6 EL4	Red	1	0.060
8 LB6 EL5	Yellow	1	0.060
8 LB6 EL6	Blu2	1	0.060
8 LB6 EL8	White	1	0.060
Blinking or steady light modules. BA15d fitting. Bulb not included.			
8 LB6 GL B1	Orange, 12-48VAC/DC	1	0.060
8 LB6 GL B3	Green, 12-48VAC/DC	1	0.060
8 LB6 GL B4	Red, 12-48VAC/DC	1	0.060
8 LB6 GL B5	Yellow, 12-48VAC/DC	1	0.060
8 LB6 GL B6	Blue, 12-48VAC/DC	1	0.060
8 LB6 GL B8	White, 12-48VAC/DC	1	0.060
8 LB6 GL M1	Orange, 24-230VAC	1	0.060
8 LB6 GL M3	Green, 24-230VAC	1	0.060
8 LB6 GL M4	Red, 24-230VAC	1	0.060
8 LB6 GL M5	Yellow, 24-230VAC	1	0.060
8 LB6 GL M6	Blue, 24-230VAC	1	0.060
8 LB6 GL M8	White, 24-230VAC	1	0.060
Sound-light pulsed or continuous modules. Bulb included.			
8 LB6 S2 B1	Orange, 24VAC/DC (80dB)	1	0.060
8 LB6 S2 B3	Green, 24VAC/DC (80dB)	1	0.060
8 LB6 S2 B4	Red, 24VAC/DC (80dB)	1	0.060
8 LB6 S2 B5	Yellow, 24VAC/DC (80dB)	1	0.060
8 LB6 S2 B6	Blue, 24VAC/DC (80dB)	1	0.060
8 LB6 S2 B8	White, 24VAC/DC (80dB)	1	0.060

General characteristics

Signal beacons are fundamental elements in manufacturing processes for the visual and audible signalling of the system status.

Technical characteristics

- Maximum operational voltage: 250V
- Consumption of sound modules: LB6 S2...: 150mA
- Material: Polycarbonate
- Connections: Screw clamp terminals, maximum 1.5mm²/16 AWG conductor section
- Tightening torque: 0.5Nm/4.5lbin
- Operating temperature: -20...+50°C
- Degree of protection: IP54; IP30 if used with 8 LB6 BP 04, 8 LB6 BP 06 or 8 LB6 BP 08.

Reference standards

Compliant with standards: IEC/EN 60947-5-1, IEC/EN 60947-1.

Combinations

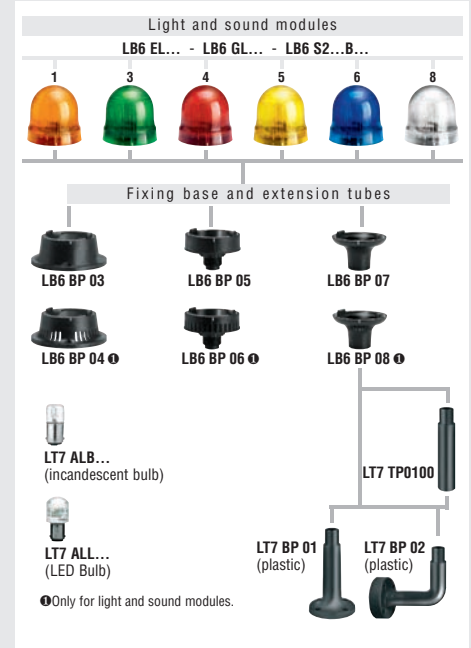

Visual code	Red	Yellow Orange	Blue	Green	White
Meaning	Danger. Emergency.	Warning and Caution. Abnormal situation.	Mandatory command.	Normal situation. Regular operation.	No specific meaning.
Sound	Fast modulated repetition or high-pitch pulsing.	Continuous short sound.	Alternating sound at constant tone	Constant and prolonged sound after an alarm.	Other sounds.
Correlated actions	Immediate intervention to deal with dangerous situation.	Control intervention required.	Intervention needed for mandatory action.	No specific action.	Depending on the situation.

Interpretation of light and sound signals for signal towers and beacons

Light and sound signals are a fundamental element for the safety of a system. To avoid incorrect interpretations, an European standard has been introduced defining an unequivocal meaning to visual or audible signalling devices. Each colour or sound alarm corresponds to a specific state of operation of the connected system and various levels of warning, as given in the following table, according to EN 981-IEC/EN 60073 standards. The white coloured module does not have a specific meaning so it can be used as one may need.

Accessories and spare parts for signal towers and beacons



LT7 BP 01



LT7 BP 02



LT7 ALB...



LT7 ALL...

Order code	Description	Qty per pkg	Wt
		n°	[kg]

Fixing bases.

8 LT7 BP 01	Horizontal surface mount, plastic, black colour with 100mm extension	1	0.045
8 LT7 BP 02	Vertical wall mount, plastic, black colour	1	0.078

Extension tube for plastic base, stackable sections.

8 LT7 TP 0100	100mm, black colour	1	0.029
----------------------	---------------------	---	-------

Incandescent bulb, 5W, BA15d fitting.

8 LT7 ALB A	12VAC/DC	10	0.006
8 LT7 ALB B	24VAC/DC	10	0.006
8 LT7 ALB E	130VAC/DC	10	0.006
8 LT7 ALB M	260VAC/DC	10	0.006

LED bulb, BA15d fitting.

8 LT7 ALL A4	Red, 12VAC/DC	1	0.010
8 LT7 ALL A8	White, 12VAC/DC	1	0.010
8 LT7 ALL B3	Green, 24VAC/DC	1	0.010
8 LT7 ALL B4	Red, 24VAC/DC	1	0.010
8 LT7 ALL B5	Yellow/Orange, 24VAC/DC	1	0.010
8 LT7 ALL B6	Blue, 24VAC/DC	1	0.010
8 LT7 ALL B8	White, 24VAC/DC	1	0.010
8 LT7 ALL E3	Green, 110-120VAC	1	0.010
8 LT7 ALL E4	Red, 110-120VAC	1	0.010
8 LT7 ALL E5	Yellow/Orange, 110-120VAC	1	0.010
8 LT7 ALL E6	Blue, 110-120VAC	1	0.010
8 LT7 ALL E8	White, 110-120VAC	1	0.010
8 LT7 ALL M3	Green, 230-240VAC	1	0.010
8 LT7 ALL M4	Red, 230-240VAC	1	0.010
8 LT7 ALL M5	Yellow/Orange, 230-240VAC	1	0.010
8 LT7 ALL M6	Blue, 230-240VAC	1	0.010
8 LT7 ALL M8	White, 230-240VAC	1	0.010

Used with yellow or orange light modules.

new

Accessories and spare parts for signal towers Ø70mm only



LT7 BM 01



LT7 BM 02



LT7 TM

Order code	Description	Qty per pkg	Wt
		n°	[kg]

Fixing bases.

8 LT7 BM 01	Horizontal surface mount, metal, black finish	1	0.099
8 LT7 BM 02	Vertical wall mount, metal	1	0.184

Extension tubes for metal base, anodised aluminium, fixed non-stackable sections.

8 LT7 TM 0100	100mm	1	0.016
8 LT7 TM 0150	200mm	1	0.024
8 LT7 TM 0300	300mm	1	0.048
8 LT7 TM 0400	400mm	1	0.064
8 LT7 TM 0500	500mm	1	0.080
8 LT7 TM 1000	1000mm	1	0.160

General characteristics

The assembly operation of the signal towers is simple and fast and does not require the use of any tools. The fixing of each element on top of the other is obtained by the bayonet insert joint, with slight pressure and simple rotating movement. There are specific white inscriptions to indicate the correct alignment.

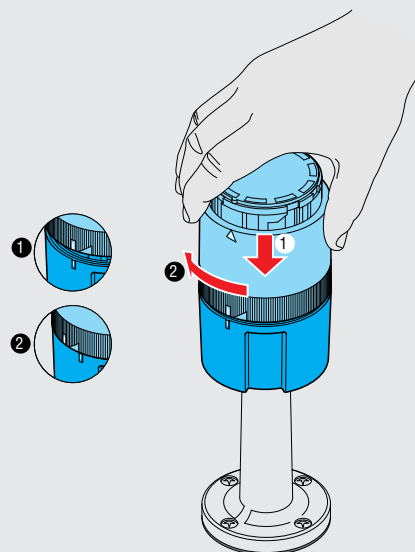

Technical characteristics

– Consumption of bulb fitted on light modules:

- LT7 ALB A: 420mA
- LT7 ALB B: 210mA
- LT7 ALB E: 43mA
- LT7 ALB M: 22mA
- LT7 ALL A...: <60mA
- LT7 ALL B...: <30mA
- LT7 ALL E...: <20mA
- LT7 ALL M...: <20mA.

Reference standards

Compliant with standards: IEC/EN 60947-5-1, IEC/EN 60947-1, UL508, CSA C22.2 n° 14.

Accessories and spare parts for signal beacons Ø62mm



LB6 BP03



LB6 BP05



LB6 BP07



LB6 BP04



LB6 BP06



LB6 BP08

Order code	Description	Qty per pkg n°	Wt [kg]
Fixing bases for light modules.			
8 LB6 BP 03	Horizontal surface mount, plastic, black colour	1	0.040
8 LB6 BP 05	For Ø22mm hole type, plastic, black colour	1	0.040
8 LB6 BP 07	For extension connection, plastic, black colour. Use with fixing bases 8 LT7 BP 01 and 8 LT7 BP 02	1	0.020
Fixing bases for sound modules.			
8 LB6 BP 04	Horizontal surface mount, plastic, black colour	1	0.040
8 LB6 BP 06	For Ø22mm hole type, plastic, black colour	1	0.040
8 LB6 BP 08	For extension connection, plastic, black colour. Use with fixing bases 8 LT7 BP 01 and 8 LT7 BP 02	1	0.020

General characteristics

The assembly operation of the signal beacons is simple and fast and does not require the use of any tools. There are specific white inscriptions to indicate the correct alignment.

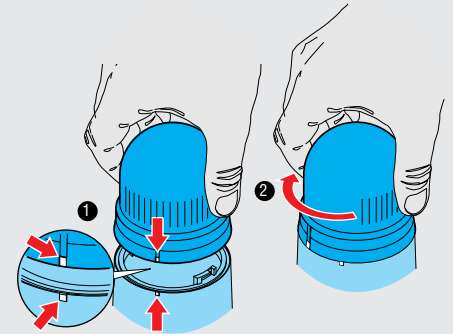

SIGNAL TOWERS Ø70mm / Ø2.75"

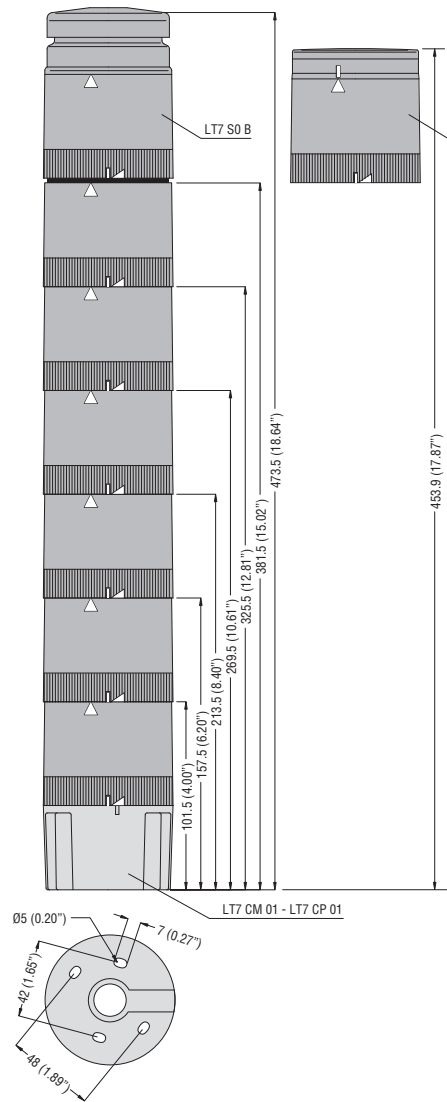

Light modules LT7 EL... LT7 GL... LT7 FL...

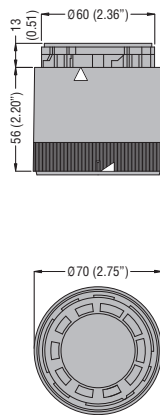

Sound modules LT7 S0 B

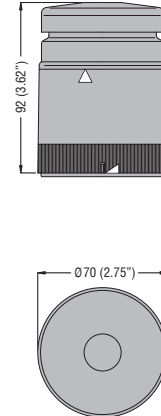

LT7 S1... LT7 S2...

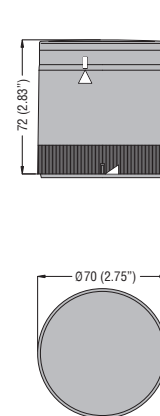

Connection modules LT7 CM 01 LT7 CP 01

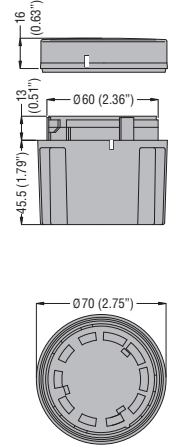

8

SIGNAL BEACONS Ø62mm / Ø2.44"

LB6 EL... LB6 GL... LB6 S2...

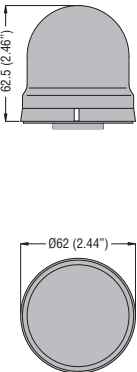

LB6... with base LB6 BP 03 and LB6 BP 04

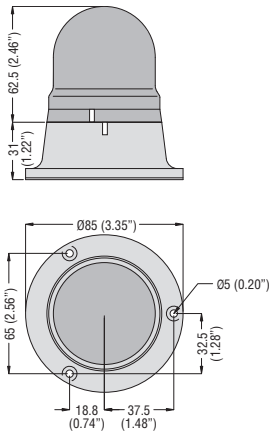

LB6... with base LB6 BP 05 and LB6 BP 06

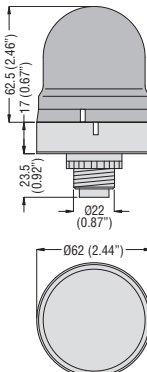

LB6... with base LB6 BP 07 and LB6 BP 08

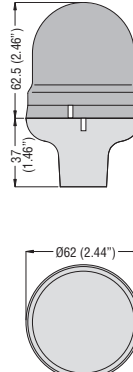

ⓘ With slits for sound light modules LB6 S2...

ACCESSORIES - Extensions and bases

LT7 BP 01

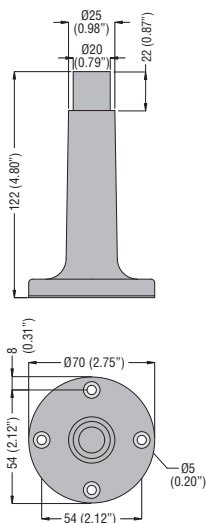

LT7 BP 02

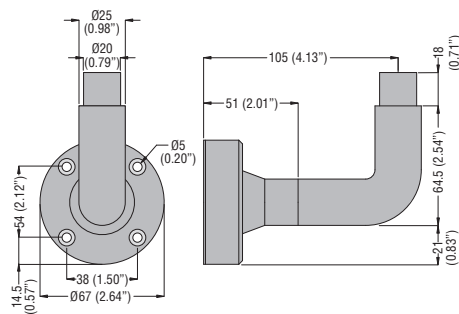

LT7 BM 01

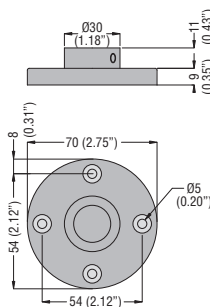

LT7 BM 02

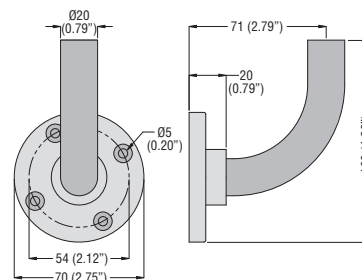

LT7 TP 0100

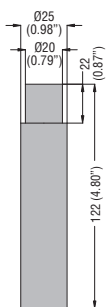

LT7 TM...

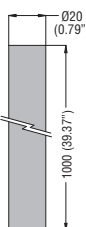

Wiring diagrams

**SIGNAL TOWERS Ø 70mm
LT7...**

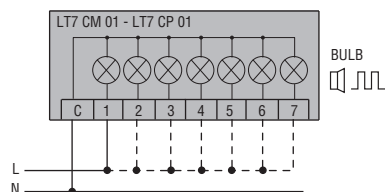

Connect terminals C and 1 as indicated to power the first module. If other modules are fitted, the respective terminals must be connected accordingly.

**SIGNAL BEACONS Ø 62mm
LB6...**

